



OPERATING INSTRUCTIONS

Opus 910

Wireless UHF System

CONTENTS

OPERATING INSTRUCTIONS Opus 910

Important Safety Information	Page	4
NE 911 / 912 / 914 Diversity Receiver	Page	8
ZAS 900 Antenna Splitter	Page	16
Connection to a PC	Page	18
S 910 C / S 910 M Handheld Transmitters	Page	19
TS 910 Beltpack Transmitter	Page	26
General Instructions for all Transmitters	Page	32
Trouble Shooting.	Page	33
Maintenance.	Page	34
Licensing.	Page	34
Components.	Page	34
Optional Accessories.	Page	35
Technical Specifications.	Page	36

OPERATING INSTRUCTIONS OPUS 910

Thank you for selecting the Opus 910 wireless system. Please take some time to read carefully through this manual before setting up the equipment.

Important:

- When you unpack the product, inspect it for transport damage. If you do find transport damage, notify the transportation company without delay. Delay in reporting transport damage could result in the loss of your rights to compensation.

Important Safety Instructions

Receiver

- READ these instructions.
- KEEP these instructions.
- HEED all warnings.
- Follow all instructions.
- Do not use this apparatus near water.
- Clean only with a dry cloth.
- Do not block any ventilation openings. Install in accordance with the manufacturer's instructions.
- Do not install near any heat sources such as radiators, heat registers, stoves or other apparatus (including amplifiers) that produce heat.
- Do not defeat the safety purpose of the polarised or grounding-type plug. A polarised plug has two blades with one wider than the other. A grounding type plug has two blades and a third grounding prong. The wide blade or the third prong are provided for your safety. If the provided plug does not fit into your outlet, consult an electrician for replacement of the obsolete outlet.
- Protect the power cord from being walked on or pinched particularly at plugs, convenience receptacles, and the point where they exit from the apparatus.
- Only use attachments/accessories specified by the manufacturer.
- Use only with the cart, stand, tripod, bracket or table specified by the manufacturer or sold with the apparatus. When a cart is used, use caution when moving the cart/apparatus combination to avoid injury from tip-over.
- Unplug this apparatus during lightning storms or when unused for long periods of time.
- Refer all servicing to qualified service personnel. Servicing is required when the apparatus has been damaged in any way, such as power-supply cord or plug is damaged, liquid has been spilled or objects have fallen into the apparatus, the apparatus has been exposed to rain or moisture, does not operate normally, or has been dropped.
- The equipment must be set up so that the mains switch, mains plug and all connection on the rear of the device are easily accessible.
- The equipment must be connected to a mains socket that has an earth contact.
- Never expose the equipment to rain or a high level of humidity. For this reason do not install it in the immediate vicinity of swimming pools, showers, damp basement rooms or other areas with unusually high atmospheric humidity.
- Do not use the device/s outside. **WARNING:** To reduce the risk of fire or electric shock, do not expose this/these device/s to rain or moisture.
- Never place objects containing liquid (e.g. vases or drinking glasses) on the equipment. Liquids in the equipment could cause a short circuit.
- Lay all connection cables so that they do not present a trip hazard.
- Check whether the connection figures comply with the existing mains supply. Serious damage could occur due to connecting the system to the wrong power supply. An incorrect mains voltage could damage the equipment or cause an electric shock.

- This equipment needs adequate ventilation. Do not cover ventilation grilles. If the heat it generates cannot be dissipated, the equipment could be damaged or flammable materials in its immediate vicinity could be ignited. Take care to ensure that the air can circulate freely through the ventilation grilles and keep flammable materials away.
- Never place naked flames near the equipment.
- If the equipment causes a blown fuse or a short circuit, disconnect it from the mains and have it checked and repaired.
- Do not open the equipment without authorisation. You could receive an electric shock. Leave all service work to authorised expert personnel.
- Do not hold the mains cable with wet hands. There must be no water or dust on the contact pins. In both cases you could receive an electric shock.
- The mains cable must be firmly connected. If it is loose there is a fire hazard.
- Always pull out the mains cable from the mains and/or from the equipment by the plug - never by the cable. The cable could be damaged and cause an electric shock or fire.
- If the power cable is connected, avoid contact of the unit with other metallic objects.
- Do not insert objects into the ventilation grilles or other openings. You could damage the equipment and/or injure yourself.
- Do not use the equipment if the mains plug is damaged.
- When installing the device into a 19" rack, make sure that the mains switch, mains plug and all connection on the rear of the device are easily accessible.
- When connecting a headphone, please make sure that the volume is turned down to minimum. Adjust the volume after putting on the headphone. Do not set the volume too high, as you could permanently damage your hearing.

Transmitter

- Protect the transmitter from moisture and sudden impacts. You could either injure yourself or others or damage the transmitter.
- Do not blow into the microphone. In a condenser microphone this could damage the transformer. It is preferable to carry out a speech trial.
- Clip-on microphones are often very compact. If they are accidentally swallowed there is a risk of choking. Always keep this type of microphone away from small children.
- Always switch off the transmitter before charging or changing the battery.
- If the transmitter is fitted with a normal battery, never charge it in the charging unit. The transmitter or the batteries could be destroyed. There is a risk of explosion.
- The normal commercial 9 V alkaline batteries can have a length tolerance of 2 - 3 mm. When changing the battery always ensure good contact.
- From time to time the battery contacts should be cleaned with a soft cloth moistened with spirits or alcohol.
- If the transmitter is not being used for weeks or months, please remove the batteries. Batteries can leak when not being used for a long time and corrode the conductor strips and components. Repair is not then possible. In this case all warranty claims are null and void. The description "leak proof" on batteries is no guarantee that they will not run out.
- Never take batteries apart yourself. The battery acid contained will damage skin and clothing.
- Do not throw used batteries into the domestic rubbish, but hand them in to local collection points.

FCC Regulation

FCC ID: OSDT5910 for TS 910 M, TS 910 C
OSDS910M for S 910 M
OSDS910C for S 910 C

Canada IC: 3628A-S910M for S 910 M
3628A-S910C for S 910 C
3628A-TS910 for TS 910 M, TS 910 C
3628A-NE91X for NE 911
3628A-NE91X for NE 912
3628A-NE91X for NE 914

NOTE: This equipment has been tested and found to comply with the limits for a Class B digital device, pursuant to Part 15 of the FCC Rules. These limits are designed to provide reasonable protection against harmful interference in a residential installation. This equipment generates, uses and can radiate radio frequency energy and, if not installed and used in accordance with the instructions, may cause harmful interference to radio communications. However, there is no guarantee that interference will not occur in a particular installation. If this equipment does cause harmful interference to radio or television reception, which can be determined by turning the equipment off and on, the user is encouraged to try to correct the interference by one or more of the following measures:

- Reorient or relocate the receiving antenna.
- Increase the separation between the equipment and receiver.
- Connect the equipment into an outlet on a circuit different from that to which the receiver is connected.
- Consult the dealer or an experienced radio/TV technician for help.

NOTICE:

Changes or modifications made to this equipment not expressly approved by beyerdynamic GmbH & Co. KG may void the FCC authorization to operate this equipment.

NOTICE:

This device complies with Part 15 of the FCC Rules and with RSS-210 of Industry Canada. Operation is subject to the following two conditions:

- (1) this device may not cause harmful interference, and
- (2) this device must accept any interference received, including interference that may cause undesired operation.

NOTICE:

This Class B digital apparatus complies with Canadian ICES-003.
Cet appareil numérique de la classe B est conforme à la norme NMB-003 du Canada.

For USA:

OPERATION OF WIRELESS MICROPHONES IN THE 700 MHZ BAND IS PROHIBITED AFTER JUNE 12, 2010.

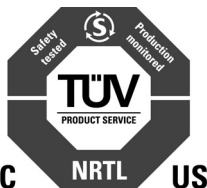

CONSUMER ALERT

Most users do not need a license to operate this wireless microphone system. Nevertheless, operating this microphone system without a license is subject to certain restrictions: the system may not cause harmful interference; it must operate at a low power level (not in excess of 50 milliwatts); and it has no protection from interference received from any other device.

Purchasers should also be aware that FCC is currently evaluating use of wireless microphone systems, and these rules are subject to change.

For more information, call the FCC at 1-888-CALL-FCC (TTY: 1-888-TELL-FCC) or visit the FCC's wireless microphone website at www.fcc.gov/cgb/wirelessmicrophones.

1. NE 911 / 912 / 914 Diversity Receiver

1.1 Controls and Indicators

NE 911 front view

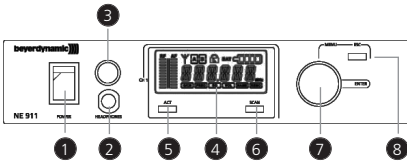

NE 912 front view

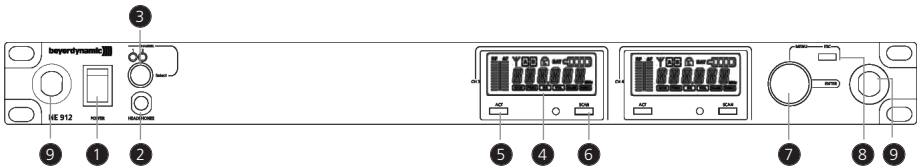

NE 914 front view

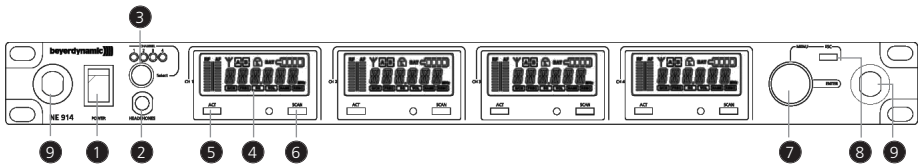

- ❶ Power switch with LED indicator
- ❷ Headphone input
- ❸ Volume control for headphone input to listen to individual receiving channels
NE 912 / 914: Press the volume control to select the receiving channel
- ❹ Display
- ❺ ACT button
- ❻ Scan button
- ❼ Menu control (for selecting different settings)
- ❽ ESC button
- ❾ Antenna connection when connecting the antennae on the front

NE 911 rear view

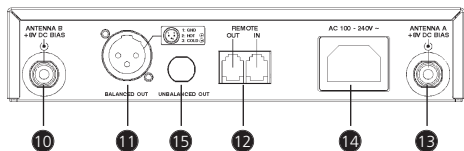

NE 912 rear view

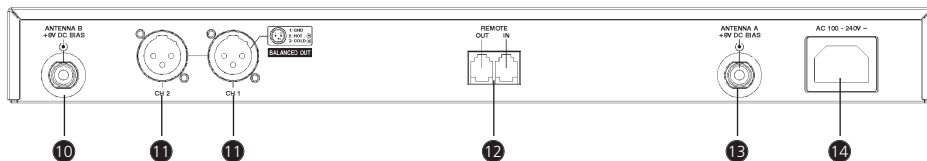

NE 914 rear view

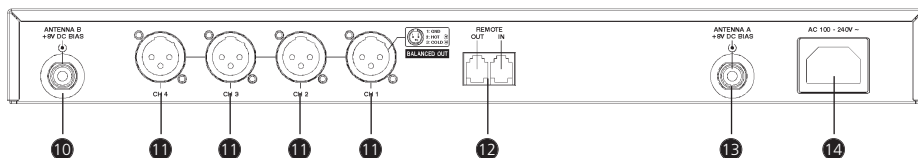

- 10 Antenna input B. TNC socket. With power supply for antenna amplifier.
- 11 AF output, 3-pin XLR, balanced
- 12 Remote connection IN / OUT
- 13 Antenna input A. TNC socket. With power supply for antenna amplifier.
- 14 Mains
- 15 **NE 911 only:** AF output, 1/4" (6.35 mm) jack, unbalanced

1.2 How to connect the Antennae

Connect the antennae to the TNC sockets ⑩ and ⑬. Set them at an angle (60°).

Please note that for diversity operation both antennae have to be connected. A weighting circuit silently switches the signal with the better S/N ratio to the output.

1.3 Setting up

1. Place the diversity receiver in the same room or area as the transmitters. Make sure the diversity receiver is placed as close as possible to the transmitter.
2. Do not place the diversity receiver near digitally controlled equipment.
3. Connect the AF-output to the corresponding input of the mixing console or amplifier.
4. Connect the receiver to AC power.
5. Switch on the receiver ①. The red LED will illuminate.
6. If you use the receiver on a tabletop, please stick the supplied rubber pads to the bottom of the receiver to ensure a sufficient ventilation.

1.4 LC-Display and Menu Settings

On the LC-Display all operating parameters such as RF and AF level will be shown. Using the "Menu" control ⑦ you can select from 6 options. The selected function is surrounded by a square frame and shown at the bottom of the LC-Display.

By selecting the ESC button ⑧ you can cancel the current entry into the menu to display the previous setting.

To select the individual receiving channels of the **NE 912 / 914** for entering the menu settings, press the menu control ⑦ until the green LED between the ACT and the SCAN button is flashing. Turn the menu control to select the receiving channel. The green LED of the selected receiving channel will flash. Press the menu control to confirm. The green LED will illuminate permanently.

The functions and operation are described in the following.

1.4.1 Diversity indication of the Receiving Channel

Each receiving module has two separate receiving circuits, one for each antenna. The signal with the better S/N ratio is switched to the output. The received diversity channel is shown in the LC-display.

1.4.2 How to read the AF and RF level

The AF or RF level is shown in the LC-display.

1.4.3 Group, Channel

- Turn the menu control **7** to select “G/CH”. The currently selected group and channel are displayed.

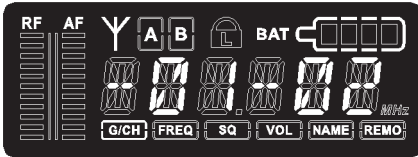

- To change the setting, press the menu control. The group number will start flashing. Turn the menu control to select the desired group. In order to confirm the selected group press the menu control.
- At the same time the channel number will start flashing. Turn the menu control to select the desired channel. In order to confirm the selected channel press the menu control.
- Press the Scan button to select a channel automatically. Press the Scan button once again and the receiver will adjust an interference-free channel automatically within the selected group. Press the menu control to confirm the selected channel.

1.4.4 Frequency

- Turn the menu control **7** to select “FREQ”. The currently selected frequency is displayed.

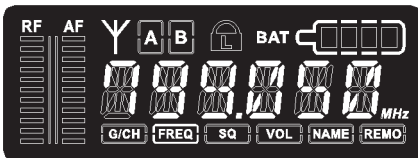

- To change the setting press the menu control. The first three digits (MHz) will start flashing. Turn the menu control to select the desired value. The first three digits of the frequency (MHz) can be selected in steps of 1 MHz. In order to confirm press the menu control.
- At the same time the last three digits (kHz) will start flashing. Turn the menu control to select the desired value. The last three digits (kHz) can be selected in steps of 25 kHz.
- In order to confirm press the menu control.

1.4.5 Squelch

- Turn the menu control **7** to select “SQ”. The currently selected squelch is displayed.

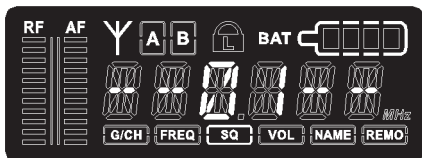

- To change the squelch level, press the menu control. The squelch level will start to flash. Turn the menu control to select the desired squelch level between 1 and 99. In order to confirm the selected squelch level, press the menu control.

1.4.6 Output Level / Mute

- Turn the menu control **7** to select “VOL”. Now you can check the output level or if the receiver is muted.

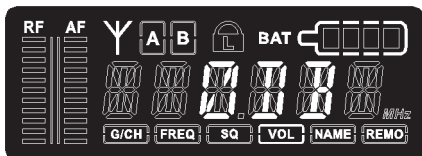

- To change the setting, press the menu control. The current setting will start to flash.
- Turn the menu control to mute the receiver or to set the output level according to the transmitter gain (0 dB, -10 dB, -20 dB, -30 dB).
- Press the menu control to confirm the setting.

1.4.7 Name

- Turn the menu control **7** to select “NAME”. A stored name is displayed or you can enter a new name.

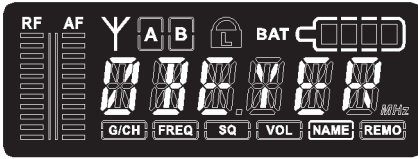

- To enter a new name press the menu control. The first digit will start to flash. Turn the menu control to select the desired letter, number or character.
- In order to confirm and to enter the second digit, press the menu control. Repeat these steps to enter all desired characters, letters or numbers. You can enter a maximum of 6 digits, symbols or letters.

1.4.8 Addressing / Control via PC

- Turn the menu control **7** to select “REMO”. The address and the status of the remotely controlled channel is displayed.

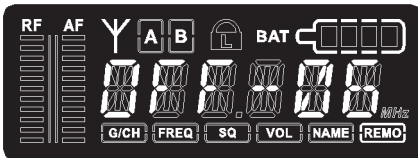

- To ensure a smooth control via PC, the receiving channels have to be addressed differently **before** using the software.

IMPORTANT:

Each channel must have **its own address**. If **two or more** channels have the same address, **errors will occur**. If the receivers are operated **without a PC**, it does not matter if two or more receivers have the same address.

- When the receiver is PC-controlled “ON” and a number are displayed. This number is the address of the appropriate channel.
- When the receiver is operated without PC “OFF” and the address are displayed.
- If you want to adjust or change the address, press the menu control. The number will start to flash. Turn the menu control to select the desired address. In order to confirm the selected address, press the menu control.

1.4.9 Lock Function

The receivers have a lock function to avoid the setting of the receiver configuration to be changed inadvertently.

How to activate the "Lock" Function

- Press the ACT and Scan buttons simultaneously.
- A red padlocked symbol is displayed.
- Now all buttons, except the ACT button are locked.
- By turning the menu control the current receiving channel configuration can still be displayed.
- The "Lock" function is still activated when the receiver is switched off and on again.

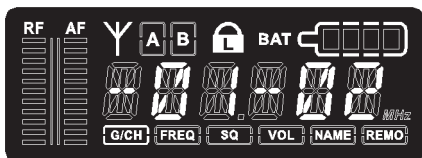

How to deactivate the "Lock" Function

- Press the ACT and Scan buttons simultaneously. The red padlocked symbol will disappear.

1.5 Frequency Transmission to Transmitter (ACT Function)

- The frequency of the receiver is transmitted to the appropriate transmitter via infrared.

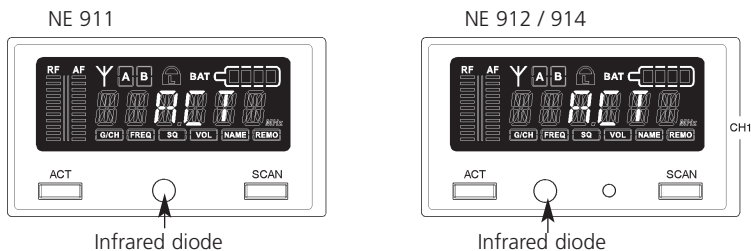

- Press the ACT button to activate the ACT function. "ACT" is displayed.
- Hold the infrared diode of the switched on transmitter 20 cm at maximum in front of the transmitting infrared diode of the receiver between the ACT and Scan button.
- The receiver displays "ACT" during the transmission.
- As soon as the transmitter displays the same frequency as the receiver, the transmission is finished. The receiver displays the state before starting the frequency transmission.

Important:

In order to avoid interferences, the frequency of **one** receiver should be transmitted to **one** transmitter only.

1.6 Connecting and Positioning of remote Antennae

In multichannel systems we recommend the use of the AT 70 A/B UHF antenna set consisting of antennae, cables, antenna boosters and mounting kit.

1. Connect the receiving antennae to the corresponding antenna inputs and place the antennae to the right and left of the receiver in the operating range where the transmitter is to be used. If necessary change the position of the antennae to improve diversity reception.
2. The distance between the two receiving antennae should be at least 1 m.

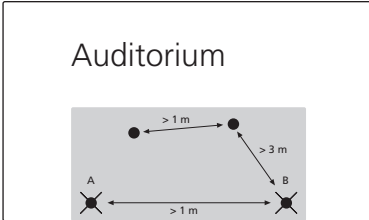

3. The distance between transmitting and receiving antennae should be at least 3 m to avoid overloading and interference between different channels. We therefore recommend installing the antennae in a high position, especially in multi-channel systems.

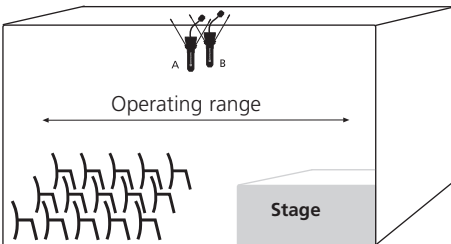

4. If the operating range of the transmitters is greater than the stage, the antennae can be mounted vertically on the ceiling. The distance between the two receiving antennae should be approximately half the total operating range.

Please note:

1. Install the receiving antennae in the same area as the transmitter.
2. To avoid interference do not install the antennae near digitally controlled components.
3. Keep a minimum distance of 0.5 m from metallic objects, including reinforced concrete walls or pillars.
4. Do not bend the antenna cables at the antenna input, and ensure that they are not subjected to undue stress.

1.7 ZAS 900 Antenna Splitter

1.7.1 Controls and Indicators

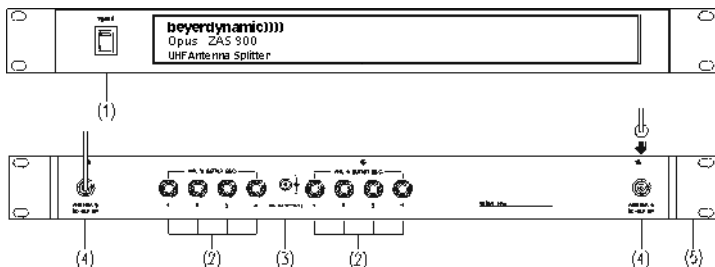

- (1) On/Off switch and power on LED. When the antenna splitter is switched on, the red LED will illuminate.
- (2) RF outputs to connect the receivers
- (3) DC-connection to connect the DC power supply unit (12 V)
- (4) Antenna sockets A/B. The antenna sockets provide a DC supply for antenna amplifiers. (DC-Out: 8 V / 170 mA)
- (5) Mounting brackets for 19" rack mounting

1.7.2 Installation

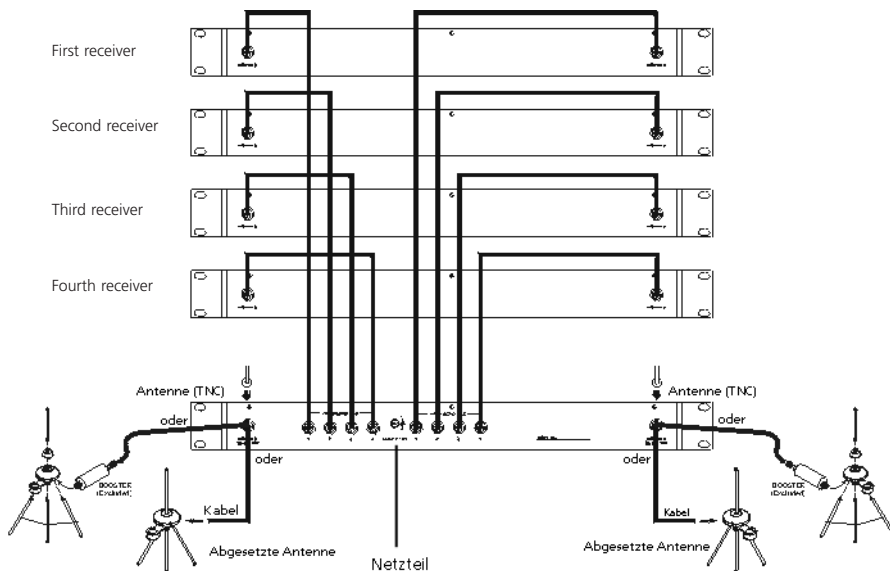

1. Mount the ZAS 900 antenna splitter and the receivers into a 19" rack by using the mounting brackets.
2. Connect the supplied antennae to the antenna sockets A/B (4). You can also use optional remote antennae. For mounting the antennae on the front use the supplied FB-30 mounting bracket.
3. Connect the receivers to the ZAS 900 antenna splitter with the supplied cables.
4. Connect the power supply unit to the DC-connection (3) and to AC power. (Attention: Make sure that the indicated voltage corresponds to the local voltage.)
5. Switch on the ZAS 900 antenna splitter (1).

1.7.3 General Information

1. The antenna sockets (4) feature a voltage of 8 V DC bias. To avoid a short circuit the sockets must not touch the rack housing.
2. For the connection of remote antennae use usual 50Ω coaxial cables. The longer the cable, the higher the RF signal loss. Therefore, the cable length should not exceed 6 m.
If you use longer cables, please use low-attenuation cables and if necessary antenna amplifiers.
3. Use 50Ω coaxial cables to connect the receivers to the ZAS 900 antenna splitter. The distance between these devices should be as short as possible. We recommend using the supplied cables.
4. Supplied Accessories:
8 x RG 58 AU cables, 40 cm (TNC)
1 pair rack mount brackets supplied with antenna cables for front mounting
1 x 12 V / 500 mA power supply unit

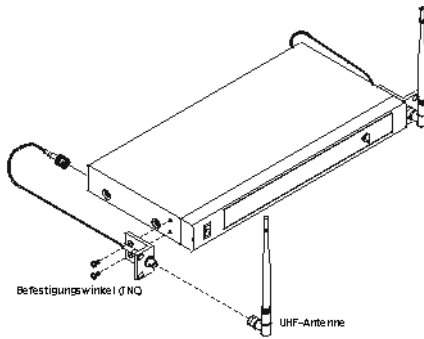

1.8 Connection to a PC

The NE 911/912/914 receiver is fitted with an RJ 11 connector **12** with an IN and OUT socket. In order to operate several receivers with a PC they have to be connected as described below.

- Connect the OUT-socket of the first receiver (RX 1) with the IN-socket of the second receiver (RX 2), connect the OUT-socket of the second receiver (RX 2) with the IN-socket of the third receiver (RX 3) and so on.
- Connect the IN-socket of the first receiver (RX 1) to the converter.
- Connect the converter to the USB interface of the PC.
- By using the PC control software, 64 channels can be operated simultaneously at maximum.
- The distance between PC and receiver should not be too long, because to ensure high-speed transmission the remote control cable should not be longer than 100 metres.

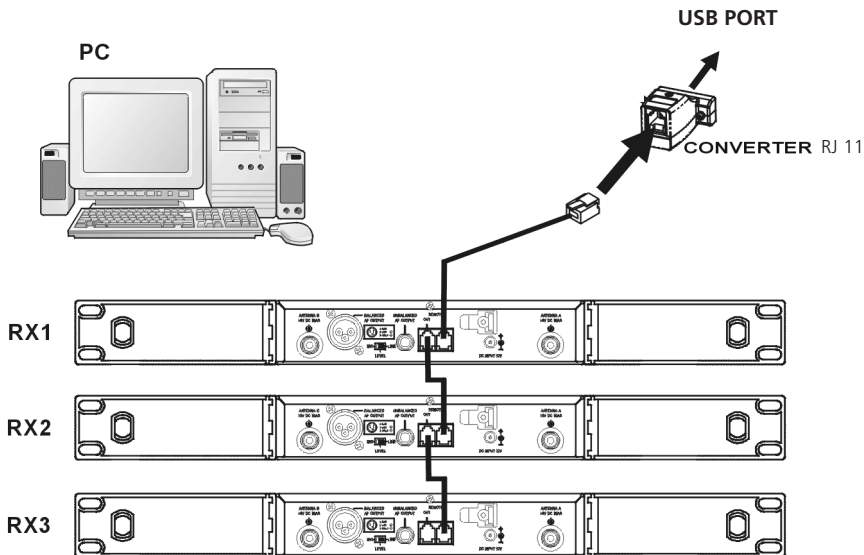

2. S 910 C / S 910 M Handheld Transmitter

2.1 Controls and Indicators

There are different condenser and dynamic microphone capsules for the handheld transmitter (refer to Optional Accessories).

The S 910 C handheld transmitter has charging contacts and can be operated with the integrated rechargeable battery pack only. For charging, the SLG 900 charger is available.

Avoid a direct contact of the charging contacts to the skin, as there is a voltage of 3 V at maximum.

S 910 C

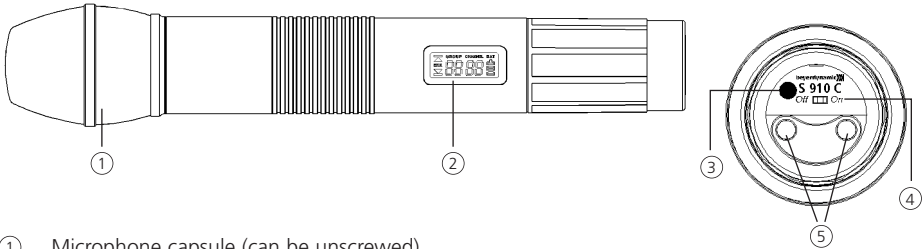

- ① Microphone capsule (can be unscrewed)
- ② LC-Display
- ③ Infrared diode (at the bottom of the transmitter)
- ④ On/Off switch (at the bottom of the transmitter)
- ⑤ Charging contacts (at the bottom of the transmitter S 910 C only)

S 910 M

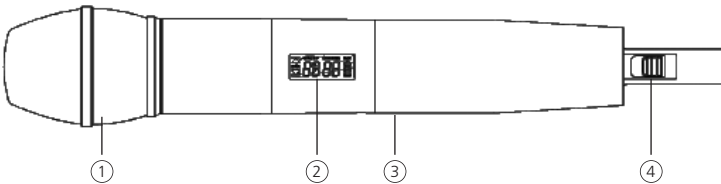

- ① Microphone capsule (can be unscrewed)
- ② LC-Display
- ③ Infrared diode (on the rear)
- ④ On/Off switch

2.2 How to insert the Batteries (S 910 M)

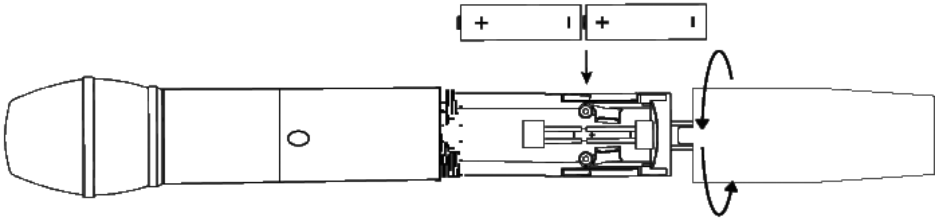

1. Unscrew the shaft of the S 910 M counter-clockwise.
2. Insert two 1.5 V batteries into the battery compartment observing polarity markings.

Note:

The **S 910 C** transmitter is powered by rechargeable batteries which **cannot** be changed by the user. If the rechargeable batteries have to be changed, please contact your beyerdynamic dealer.

2.3 LC-Display



1. "ERR" Message: When the "ERR" message is displayed, there is an error.
ERR no03: The frequency you want to program is above the switching bandwidth of the transmitter. Use a receiver with an appropriate frequency group. (At this time the microphone is still operating and the frequency remains unchanged. To clear the displayed "ERR" message switch off the handheld transmitter and on again.)
ERR no04: The frequency you want to program is below the switching bandwidth of the transmitter. Use a receiver with an appropriate frequency group. (At this time the microphone is still operating and the frequency remains unchanged. To clear the displayed "ERR" message switch off the handheld transmitter and on again.)
2. "Group" & "Channel": When both indications are displayed, it means that you are using the pre-programmed frequency of the receiver.
3. "Channel": If "Channel" is displayed only, it means that you are using a frequency which is not pre-programmed.

2.4 Battery Status

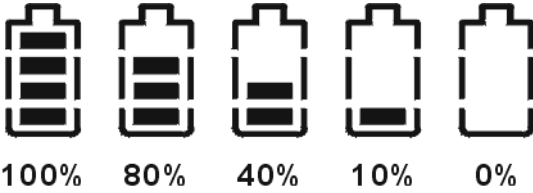

- When the battery is exhausted, the LED at the bottom of the handheld transmitter will illuminate. Replace the battery. When "PoFF" is displayed, the transmitter is switched off, if the battery voltage is too low.

2.5 How to switch off the Handheld Transmitter

When the ON/OFF switch at the bottom of the transmitter is switched to "OFF", at first "PoFF" is displayed and as soon as the transmitter is completely off the display is blank. Wait one second if you want to switch on the transmitter again immediately.

2.6 How to change the Microphone Capsule

There are different microphone capsules available for the handheld transmitter. If you want to change the microphone capsule, turn it anti-clockwise to unscrew it from the transmitter. Put the selected microphone capsule onto the transmitter and turn it clockwise to tighten.

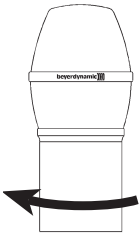

CM 930

Cardioid condenser microphone capsule for vocals and speech applications. For maximum gain before feedback. Weight 191 g.

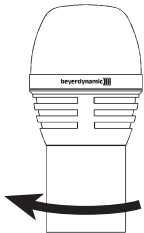

DM 960

Hypercardioid dynamic microphone capsule. Suitable for vocals and broadcasting applications. Weight 191 g.

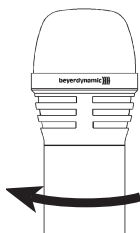

DM 969

Supercardioid dynamic microphone capsule. Suitable for vocals.
Weight 131 g.



EM 981

Cardioid electret condenser microphone capsule for solo vocals,
conferences and speech. Weight 191 g.



RM 510

Cardioid dynamic ribbon microphone head.
Weight 165 g.

2.7 Maintenance

- Protect the handheld transmitter from humidity, knocks and shock. Avoid dropping the transmitter at all times.
- For cleaning metal surfaces, use a soft cloth moistened with methylated spirits or alcohol.
- As soon as your microphone sounds dull, you should clean the integrated pop shield. Proceed as described in the following.

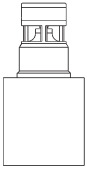
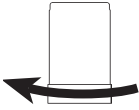

CM 930

- Unscrew the microphone capsule (turn anti-clockwise).
- Unscrew the wire mesh pop shield (turn anti-clockwise).
- Clean the pop shield under clear running water.
- Allow the pop shield to dry overnight before you replace it.
- The wire mesh pop shield **cannot** be cleaned in a dishwasher.

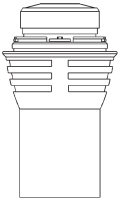

DM 960

- Unscrew the upper part of the microphone basket (turn anti-clockwise).
- Clean it under clear water.
- Let the pop shield dry overnight before you replace it.
- The upper part of the microphone basket **cannot** be cleaned in a dishwasher.

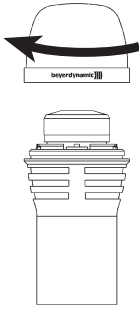

DM 969

- Unscrew the upper part of the microphone basket (turn anti-clockwise).
- Pull out the foam pop shield and clean it under clear running water.
- If necessary, use a mild washing-up liquid.
- Dry it afterwards with a hairdryer or allow it to dry overnight.
- Place the dry pop shield inside the microphone basket and replace the microphone basket by screwing it on clockwise.

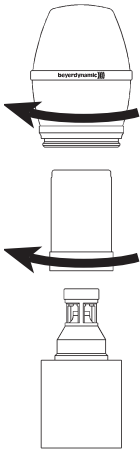

EM 981

- Unscrew the microphone capsule (turn anti-clockwise).
- Unscrew the wire mesh pop shield (turn anti-clockwise).
- Clean the pop shield under clear running water.
- Allow the pop shield to dry overnight before you replace it.
- The wire mesh pop shield **cannot** be cleaned in a dishwasher.

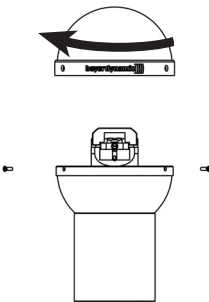

RM 510

- Loosen the screws.
- Unscrew the upper part of the microphone head (turn anti-clockwise).
- Clean the upper basket under clear running water.
- Allow the upper basket to dry overnight before you replace it.
- The upper basket **cannot** be cleaned in a dishwasher.

2.8 How to adjust the Gain

- To adjust the gain unscrew the complete microphone head with the upper shaft as indicated by the arrows.
- Use a screwdriver to select the gain (0 dB, 10 dB, 20 dB, 30 dB).
- Lowest gain = 0 dB
Highest gain = 30 dB

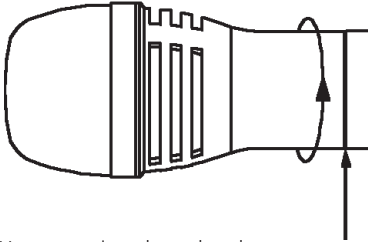

Unscrew microphone head

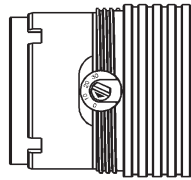

Select gain

2.9 How to set the Low-cut Filter

- The CM 930 and EM 981 microphone capsules feature a low-cut filter to compensate the close-miking effect which usually occurs with directional microphones. To set the low-cut filter unscrew the complete microphone head with the upper shaft as indicated by the arrows.
- At the bottom of the microphone head you can set the low-cut filter.
- **Standard setting: linear (position Lin)**

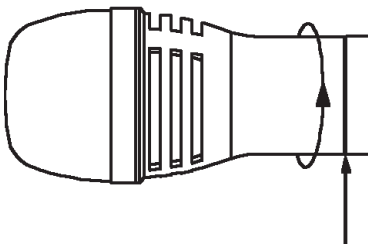

Unscrew microphone head

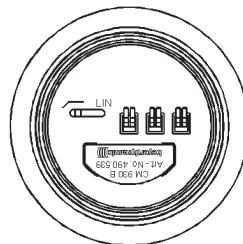

Set low-cut filter

3. TS 910 Beltpack Transmitter

The TS 910 C beltpack transmitter provides charging contacts and can be powered by the optional beyerdynamic TS 900 AP rechargeable battery pack. For charging, the SLG 900 charger is available. With this charger the TS 900 AP battery pack inside the TS 910 C beltpack transmitter can be recharged only, no standard rechargeable batteries.

3.1 Controls and Indicators

TS 910 C

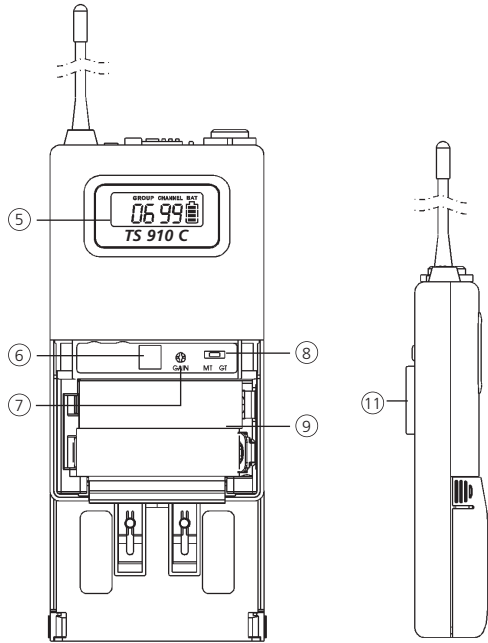
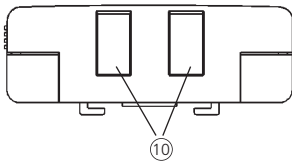
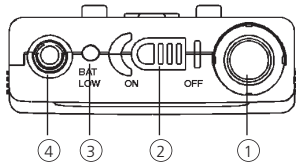

- ① AF input, 4-pin mini XLR for microphones (lavalier, neckworn mics). For connection please refer to chapter 3.5 "AF Connection".
- ② ON/OFF switch (ON = switch to "ON"-position; OFF = switch to "OFF" position). Switch off the transmitter when not in use.
- ③ **TS 910 C only:** Battery status LED to indicate the power on / off and battery status.
 - (a) When the beltpack transmitter is switched on this LED will flash for a moment to indicate the normal battery status.
 - (b) When the LED stays red after having switched on the transmitter the battery is too weak and must be replaced.
- ④ Transmitting antenna
- ⑤ LC-Display
- ⑥ Infrared receiving diode for ACT function.
- ⑦ Gain control to adjust input gain.
- ⑧ GT/MT switch: When you use electric guitars this switch must be in the "GT" position. In the GT mode the gain control is deactivated. Switch to the "MT" position when you use condenser and wired microphones. In the MT mode the gain control is activated.
- ⑨ Battery compartment and cover for two 1.5 V batteries (AA) or TS 900 AP rechargeable battery pack.
- ⑩ **TS 910 C only:** Charging contacts for TS 900 AP battery pack only (not supplied).
- ⑪ Removable belt clip can be rotated 360°. To remove use a screwdriver at a 45° angle.

TS 910 M

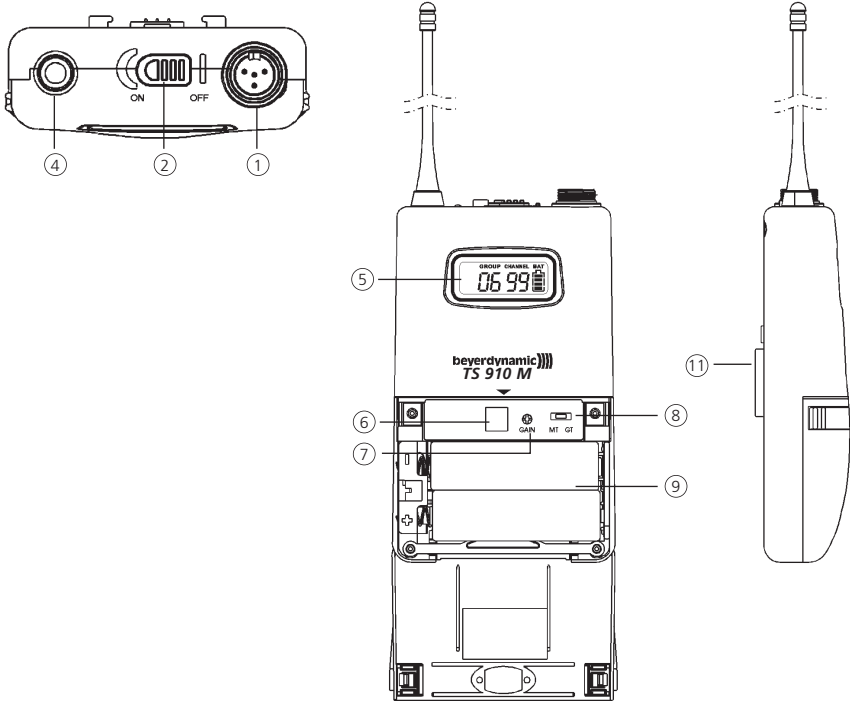

- ① AF input, 4-pin mini XLR for microphones (lavalier, neckworn mics).
For connection please refer to chapter 3.5 "AF Connection".
- ② ON/OFF switch (ON = switch to "ON"-position; OFF = switch to "OFF" position).
Switch off the transmitter when not in use.
- ④ Transmitting antenna
- ⑤ LC-Display
- ⑥ Infrared receiving diode for ACT function.
- ⑦ Gain control to adjust input gain.
- ⑧ GT/MT switch: When you use electric guitars this switch must be in the "GT" position.
In the GT mode the gain control is deactivated. Switch to the "MT" position when you
use condenser and wired microphones. In the MT mode the gain control is activated
- ⑨ Battery compartment and cover for two 1.5 V batteries (AA).
- ⑪ Removable belt clip can be rotated 360°. To remove use a screwdriver at a 45° angle.

This is how to remove the belt clip

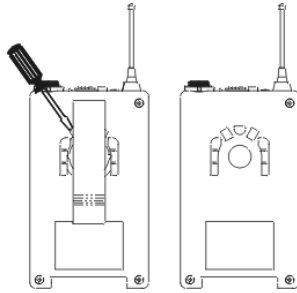

3.2 How to insert the Batteries / rechargeable Battery Pack

1. Push down the two snap locks on the right and left of the battery compartment and open it. Remove the batteries. Refer to Fig. 1.
2. Insert two 1.5 V batteries into the battery compartment observing polarity markings. Refer to Fig. 2. The battery pack is secured mechanically against confusing the poles. Then close the battery compartment again.

TS 910 M: Insert batteries

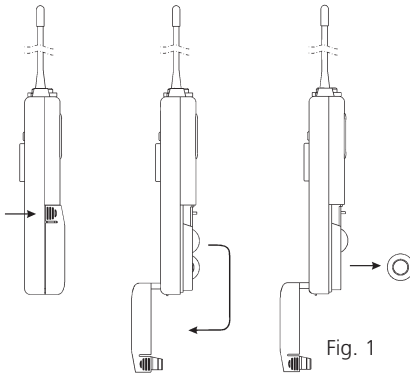

Fig. 1

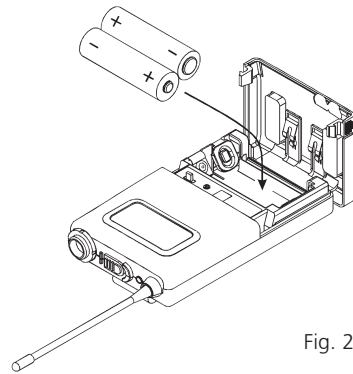

Fig. 2

TS 910 C: Insert rechargeable battery pack

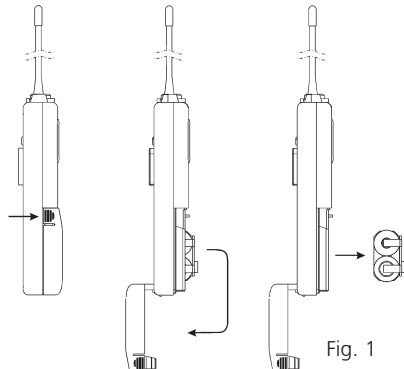

Fig. 1

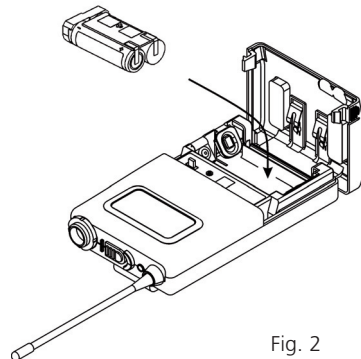
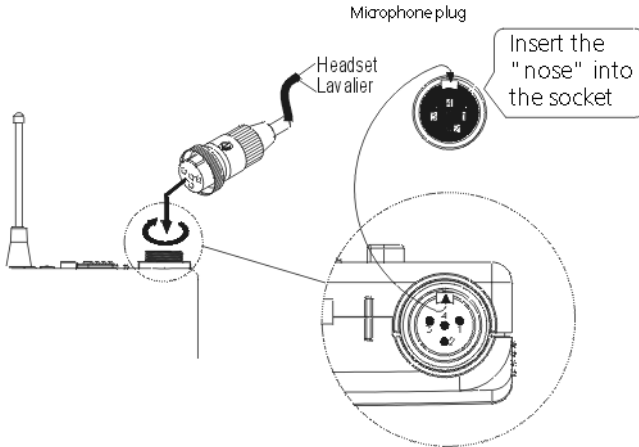

Fig. 2

3.3 Setting up

1. Push down the two snap locks on the right and left of the battery compartment and open it. Now you can adjust the GT/MT switch ⑧ and the gain control ⑦.
2. Make sure that the transmitter and receiver are on the same frequency.
3. The LED of the TS 910 C will flash for a moment when the transmitter is switched on and indicates the normal battery status. When the LED fails to flash, there is no battery inserted, the battery is leaking or inserted incorrectly. The battery status of the **TS 910 M** can be seen in the LC-Display.
4. Connect the microphone or instrument to the input socket ①. Refer to illustration below.



3.4 Adjusting the Input Gain

1. Switch on the TS 910 beltpack transmitter with the ON/OFF switch ②. Turn the gain control ⑦ fully anti-clockwise to minimum gain.
2. Speak into the microphone at the maximum level you expect to use. We recommend you use the letter "U" as a spoken "U" has a relatively good sine wave shape. Adjust the gain control ⑦ to the desired gain. On the NE 911/912/914 receiver the AF level must not show any clipping. When miking instruments, play at the maximum level you expect to use.

3.5 AF Connection

- (1) 2-Wire Electret Condenser Microphone Capsule

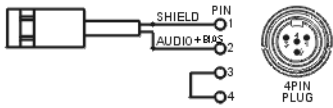

e.g. MCE 5.18,
MCE 10.18,
MCE 60.18

- (2) 3-Wire Electret Condenser Microphone Capsule

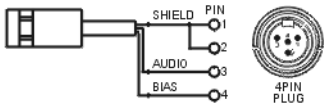

e.g. Opus 54.18,
Opus 55.18,
Opus 56.18,
MCE 7.18

- (3) Dynamic Microphone

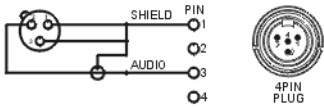

- (4) Electric Guitar

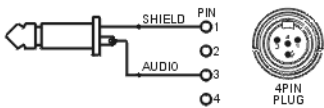

- (5) Line-in (impedance 8Ω, attenuation 10 dB)

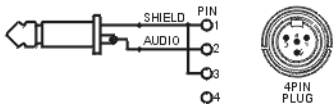

3.6 LC-Display



1. "ERR" Message: When the "ERR" message is displayed, there is an error.
ERR no03: The frequency you want to program is above the switching bandwidth of the transmitter. Use a receiver with an appropriate frequency group. (At this time the microphone is still operating and the frequency remains unchanged. To clear the displayed "ERR" message switch off the transmitter and on again.)
ERR no04: The frequency you want to program is below the switching bandwidth of the transmitter. Use a receiver with an appropriate frequency group. (At this time the microphone is still operating and the frequency remains unchanged. To clear the displayed "ERR" message switch off the transmitter and on again.)
2. "Group" & "Channel": When both indications are displayed, it means that you are using the pre-programmed frequency of the receiver.
3. "Channel": If "Channel" is displayed only, it means that you are using a frequency which is not pre-programmed.

3.7 Battery Status

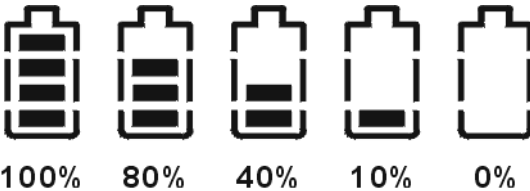

- When the battery is exhausted, the LED ③ (TS 910 C only) will illuminate. Replace or recharge the battery. When "PoFF" is displayed, the transmitter will automatically switch off to avoid an over-discharge of the battery.

3.8 How to switch off the Beltpack Transmitter

When the ON/OFF switch is switched to "OFF", at first "PoFF" is displayed and as soon as the transmitter is completely off the display is blank. Wait one second if you want to switch on the transmitter again immediately.

4. General Instructions for all Transmitters

4.1 Battery Change

- Switch the transmitter off before changing the battery.
- If you do not use the transmitter for several weeks or months, please remove the battery as it can leak after some time and damage parts of the transmitter. Even "leak proof" may leak after some time. Damage caused by leaking batteries is not covered under warranty.
- Clean the battery contacts from time to time by using a soft cloth moistened with spirits or alcohol.
- Please do not throw used battery packs away with your household rubbish, but take them to your local collection points.
- When using the S 910 C handheld transmitter or TS 910 C beltpack transmitter (fitted with TS 900 AP rechargeable battery pack) use the beyerdynamic SLG 900 charger only.

4.2 Before the Soundcheck

1. Check the transmitter battery and replace or recharge it if necessary. Use fresh alkaline batteries only or recharge the rechargeable batteries inside the S 910 C handheld transmitter or TS 910 C beltpack transmitter (fitted with TS 900 AP).
2. When the transmitter is switched off and immediately switched on again, it is possible that the transmitter remains switched off. The cause is the function that allows to switch the transmitter on / off silently. Should this problem occur during operation, the battery might have contact problems. After switching off the transmitter you should wait at least 1 second, until you switch the transmitter on again.
3. Check the performance area for dropouts. If you find any dropouts, try to eliminate them by repositioning the antennae or the receiver.
4. The receiving antennas should be placed so that the distance between receiving antennae and transmitter is at least 3 m. If necessary, use remote antennae (AT 70 A/B).

4.3 Positioning of Transmitters if Interference occurs

Put all transmitters in their position and switch them on. Switch each transmitter off one at a time and check the receiver for interference in the corresponding channel.

The interference is possibly eliminated by changing the squelch (refer also to chapter 1.4.5 "Squelch").

When using multi-channel-systems, please contact beyerdynamic. Interferences can also be caused by DVB-T television transmitters in the neighbourhood.

4.4 What to Do to avoid Feedback

Feedback is caused by your microphone getting too close to a loudspeaker.

We recommend:

- Move away from the loudspeaker.
- Turn the microphone away from the loudspeaker.

5. Trouble Shooting

5.1 NE 911 / 912 / 914 Diversity Receiver

Problem	Possible Cause	Solution
No function	<ul style="list-style-type: none"> Power supply is interrupted, power supply unit is not connected to the mains and / or to receiver 	<ul style="list-style-type: none"> Connect the receiver to AC power
No reception	<ul style="list-style-type: none"> Transmitter is not switched on Transmitter works on a different channel Defect in the antenna cables with remote antennae 	<ul style="list-style-type: none"> Switch on the transmitter Adjust the correct frequency with the ACT function Check the antenna cables
Distorted sound	<ul style="list-style-type: none"> Input amplifier of the connected mixer is overloaded 	<ul style="list-style-type: none"> Use the gain control of the mixer or adjust the volume
"CLIP" indication on receiver	<ul style="list-style-type: none"> Transmitter is overloaded 	<ul style="list-style-type: none"> Reduce the sensitivity of the transmitter or increase the distance between microphone and sound source.
No sound, RF-indication is okay, AF- indication is missing during modulation	<ul style="list-style-type: none"> Wrong indication caused by strong interference signals No microphone connected to TS 910 beltback transmitter 	<ul style="list-style-type: none"> Choose another receiving channel Connect a suitable microphone

5.2 Handheld and Beltback Transmitter

Problem	Possible Cause	Solution
No function	<ul style="list-style-type: none"> Transmitter and receiver have different frequencies Insufficient battery voltage Poor battery contact, battery inserted incorrectly 	<ul style="list-style-type: none"> Check if transmitter and receiver have the same frequency Replace the batteries or recharge them, if you use rechargeable batteries Check the battery and insert it again
No RF-indication at the receiver	<ul style="list-style-type: none"> Transmission distance between transmitter and receiver is too big 	<ul style="list-style-type: none"> Reduce the distance between transmitter and receiver
Noise/chirping	<ul style="list-style-type: none"> Interference from other transmitters Two transmitters are on the same frequency Battery of the transmitter is too weak 	<ul style="list-style-type: none"> Switch off the other transmitters Change the frequency of one transmitter Replace the batteries

6. Maintenance

In the unlikely event of equipment failure, the product should be returned to your beyerdynamic dealer. Unauthorised attempts at repair may invalidate the warranty.

7. Licensing

In most countries around the world, wireless systems must be approved for use by the authorities and it may be necessary to obtain a licence to use it legally. Your local beyerdynamic dealer will be able to give you details on wireless system regulations for your area.

The components of the Opus 910 system are approved according to the directive 99/5/EEC:

TS 910 M, TS 910 C

S 910 M, S 910 C

under the CE 0682  identification.

8. Components

Receiver

NE 911	1-channel true diversity receiver, 482 – 554 MHz (US)	Order # 705.004
	same as above, but 554 – 626 MHz (US)	Order # 705.012
	same as above, but 626 – 698 MHz (US)	Order # 705.020
NE 912	2-channel true diversity receiver, 482 - 554MHz (US)	Order # 705.071
	same as above, but 554 – 626 MHz (US)	Order # 705.098
	same as above, but 626 – 698 MHz (US)	Order # 705.101
NE 914	4-channel true diversity receiver, 482 – 554 MHz (US)	Order # 705.160
	same as above, but 554 – 626 MHz (US)	Order # 705.179
	same as above, but 626 – 698 MHz (US)	Order # 705.187

Handheld Transmitter

S 910 M	UHF handheld transmitter, metal housing, black, 482 – 518 MHz (US)	Order # 705.233
	same as above, but 518 – 554 MHz (US)	Order # 705.241
	same as above, but 554 – 590 MHz (US)	Order # 705.268
	same as above, but 590 – 626 MHz (US)	Order # 705.276
	same as above, but 626 – 662 MHz (US)	Order # 705.284
	same as above, but 662 – 698 MHz (US)	Order # 705.292

S 910 C	UHF handheld transmitter, plastic housing, black, with charging contacts, 482 – 518 MHz (US)	Order # 705.381
	same as above, but 518 – 554 MHz (US)	Order # 705.403
	same as above, but 554 – 590 MHz (US)	Order # 705.411
	same as above, but 590 – 626 MHz (US)	Order # 705.438
	same as above, but 626 – 662 MHz (US)	Order # 705.446
	same as above, but 662 – 698 MHz (US)	Order # 705.454

Beltpack Transmitter

TS 910 M	UHF beltpack transmitter, metal housing, 482 – 518 MHz (US) . . .	Order # 705.691
	same as above, but 518 – 554 MHz (US)	Order # 705.705
	same as above, but 554 – 590 MHz (US)	Order # 705.713
	same as above, but 590 – 626 MHz (US)	Order # 705.721
	same as above, but 626 – 662 MHz (US)	Order # 705.748
	same as above, but 662 – 698 MHz (US)	Order # 705.756

TS 910 C	UHF beltpack transmitter, plastic housing, with charging contacts, 482 – 518 MHz (US)	Order # 705.543
	same as above, but 518 – 554 MHz (US)	Order # 705.551
	same as above, but 554 – 590 MHz (US)	Order # 705.578
	same as above, but 590 – 626 MHz (US)	Order # 705.586
	same as above, but 626 – 662 MHz (US)	Order # 705.594
	same as above, but 662 – 698 MHz (US)	Order # 705.608

9. Optional Accessories

NE 911 / 912 / 914 Diversity Receiver

Antenna Splitter

ZAS 900	UHF antenna splitter, active, 19" housing, incl. cable set, 480 - 800 MHz	Order # 497.541
---------	--	-----------------

Antennae

AT 70 A/B Set	UHF antenna set for NE 911 / 912 / 914, cpl. with 2 x AT 70 B TNC booster, 2 x AT 70 TNC antenna and 2 x MS 10 mounting kit	Order # 459.976
FBC 71	Cable rear-to-front for NE 911 / 912 / 914 and ZAS 900 (1 pair)	Order # 469.823
FB 72	Mounting bracket, metal, for mounting of ZAS 900 into a 19"-rack	Order # 469.807

Individual Components - Software

USB Adapter	Opus 910 USB Adapter	Order # 490.776
RJ 11 Cable	Opus 910 RJ 11	Order # 490.784
CD ROM	Opus 910 CD-ROM	Order # 490.792

S 910 Handheld Transmitter

Microphone Capsules

CM 930 B	Condenser, cardioid, black	Order # 490.539
CM 930 S	Condenser, cardioid, silver	Order # 491.721
DM 960 B	Dynamic, hypercardioid, black	Order # 490.490
DM 960 S	Dynamic, hypercardioid, silver	Order # 490.504

DM 969 S	Dynamic, supercardioid, silver	Order # 490.512
EM 981 S	Electret condenser, cardioid, silver.	Order # 490.520
RM 510	Ribbon, dynamic, cardioid, silver.	Order # 703.109

TS 910 Beltpack Transmitter

Microphones

MCE 5.18	Condenser clip-on microphone, omnidirectional, black	Order # 471.879
MCE 10.18	Condenser clip-on microphone, cardioid, black.	Order # 471.895
MCE 60.18	Condenser clip-on microphone, omnidirectional, black	Order # 469.548
Opus 54.18	Neckworn microphone, cardioid, black	Order # 464.945
Opus 55.18	Neckworn microphone, omnidirectional, black	Order # 465.356
TG-X 54.18	Neckworn microphone, supercardioid, black.	Order # 700.061
TG-X 55.18	Neckworn microphone, omnidirectional, black	Order # 700.096

Cable

MJ 41 G	Cable for instruments with 1/4" jack (6.35 mm), for TS 910 (C / M) beltpack transmitter.	Order # 460.087
---------	---	-----------------

S 910 C Handheld Transmitter and TS 910 Beltpack Transmitter

NiMH battery	Rechargeable battery, 1.2 V / 2500 mAh for S 910 C	Order # 903.442
TS 900 AP	Rechargeable battery pack, NiMH, 2 x 1.5 V (AA) for TS 910 C. .	Order # 486.957
SLG 900	Charger with two charging compartments for S 910 C or TS 910 C	Order # 485.292

10. Technical Specifications

NE 911 / 912 / 914 Diversity Receiver

Operating principle.	True diversity receiver (UHF)	
Frequency range.	482 – 554 MHz (US) 554 – 626 MHz (US) 626 – 698 MHz (US)	
Power consumption	NE 911: 10 W NE 912: 15 W NE 914: 25 W	
Power consumption in stand-by mode	NE 911 / 912 / 914: 2.5 W	
Switching bandwidth	72 MHz	
Sensitivity	2 µV	
Antenna connection.	2 x TNC	
Nominal deviation	± 40 kHz	
Output level	1.2 V	
Comander system.	NE572	
Signal-to-noise ratio	> 110 dB(A)	
T.H.D.	< 0.5% at 1 kHz	
Squelch	2 µV - 1 mV, adjustable	
Power supply	12 V - 15 V DC	
Mains	100 V - 240 V AC	
Dimensions.	NE 911 (L x W x H):	210 x 235 x 43 mm
	NE 912 / 914 (L x W x H):	482 x 270 x 43 mm
Weight.	NE 911:	1.36 kg
	NE 912:	2.75 kg
	NE 914:	3.1 kg
Minimum distance of the profiles when mounting into a 19" rack		446 mm

S 910 (M / C) + CM 930 / DM 960 / DM 969 / RM 510 / EM 981 Handheld Transmitter

Polar pattern	Hypercardioid (S 910 + DM 960) Supercardioid (S 910 + DM 969) Cardioid (S 910 + RM 510, S 901 + EM 981, S 910 + CM 930)	
Transducer type	True condenser (S 910 + CM 930) Dynamic (S 910 + DM 960, S 910 + DM 969) Ribbon, dynamic (S 910 + RM 510) Electret condenser (S 910 + EM 981)	
Frequency range	482 – 518 MHz (US) 518 – 554 MHz (US) 554 – 590 MHz (US) 590 – 626 MHz (US) 626 – 662 MHz (US) 662 – 698 MHz (US)	
Modulation	FM	
Nominal deviation	± 40 kHz	
Radiated transmitter power	10 mW	
Compander system	NE572	
Max. SPL	146 dB	
AF transmission range		
S 910 + DM 960	55 - 18,000 Hz (close miking 2 cm) at 80 dB SPL	
S 910 + DM 969	65 - 16,000 Hz (close miking 2 cm) at 80 dB SPL	
S 910 + EM 981	50 - 18,000 Hz (close miking 2 cm) at 80 dB SPL	
S 910 + CM 930	40 - 20,000 Hz (close miking 2 cm) at 80 dB SPL	
S 910 + RM 510	70 - 14,000 Hz (close miking 2 cm) at 80 dB SPL	
Rear attenuation	-20 dB at 1 kHz / 120° (S 910 + DM 960) -15 dB at 1 kHz / 145° (S 910 + DM 969) -15 dB at 1 kHz / 180° (S 910 + EM 981) -20 dB at 1 kHz / 180° (S 910 + CM 930) -18 dB at 1 kHz (S 910 + RM 510)	
Signal-to-noise ratio	> 110 dB	
T.H.D.	< 0.5% at 1 kHz	
Transmission range	100 m	
Power supply	2 x 1.5 V batteries (AA) or rechargeable batteries	
Current consumption	approx. 85 mA	
Operating time	> 20 hours with alkaline batteries	
Dimensions		
Length	S 910 C: 188 mm	S 910 M: 210.5 mm
Shaftø	S 910 C: 38 mm	S 910 M: 38 mm
Weight with batteries	S 910 C: 169 g	S 910 M: 172 g

TS 910 (C / M) Beltpack Transmitter

Frequency range	482 – 518 MHz (US) 518 – 554 MHz (US) 554 – 590 MHz (US) 590 – 626 MHz (US) 626 – 662 MHz (US) 662 – 698 MHz (US)
Modulation	FM
Nominal deviation	± 40 kHz
Radiated transmitter power	20 mW
Compander system	NE572
Signal-to-noise ratio	> 110 dB
T.H.D.	< 0.5% at 1 kHz
Frequency response	50 Hz - 18,000 Hz
Gain	10 mV - 0.3 V adjustable, at nominal deviation
Power supply	2 x 1.5 V batteries (AA) or rechargeable batteries
Current consumption	approx. 85 mA
Operating time	> 20 hours with alkaline batteries
Dimensions (L x W x D).	TS 910 C: 110 x 63 x 21.5 mm TS 910 M: 110 x 65.5 x 24.5 mm
Weight	TS 910 C: 155 g TS 910 M: 156 g
4-pin connection	Pin 1 = Ground, Pin 2 = IN1, Pin 3 = IN2, Pin 4 = +5 V; refer also to chapter 3.5 “AF Connection”

ZAS 900 Antenna Splitter

Frequency range	480 - 800 MHz
Inputs	2 x 50 Ω (TNC)
Outputs	8 x 50 Ω (TNC)
Amplification	0 dB ±3 dB
Decoupling attenuation	> 15 dB
Power supply	12 V - 15 V DC, 1A current min.
Mains	110 - 240 V AC
Current consumption	approx. 170 mA
Dimensions (L x W x H).	482 x 190 x 44 mm
Weight	approx. 1547 g

beyerdynamic))))

beyerdynamic GmbH & Co. KG
Theresienstr. 8 | 74072 Heilbronn – Germany
Tel. +49 (0) 7131 / 617 - 0 | Fax +49 (0) 7131 / 617 - 204
info@beyerdynamic.de | www.beyerdynamic.com

For further distributors worldwide, please go to www.beyerdynamic.com

