



KRAMER ELECTRONICS LTD.

USER MANUAL

MODEL:

TP-578H

DGKat to HDMI Receiver

P/N: 2900-300189 Rev 1

TP-578H DGKat to HDMI Receiver



This guide helps you install and use your product for the first time. For more detailed information, go to <http://bit.ly/k-prod-downloads> to download the latest manual or scan the QR code on the left.

Step 1: Check what's in the box

- TP-578H DGKat™ to HDMI Receiver
- Power adapter (12V DC)
- 4 Rubber feet
- 1 Quick start guide
- 1 User Manual

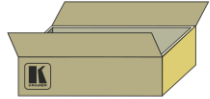

Save the original box and packaging materials in case your Kramer product needs to be returned to the factory for service.

Step 2: Install the TP-578H

Mount the device in a rack (using the optional RK-3T rack adapter available for purchase) or place it on a shelf.

Step 3: Connect the input and outputs

Always switch off the power to all devices before connecting them to your TP-578H.

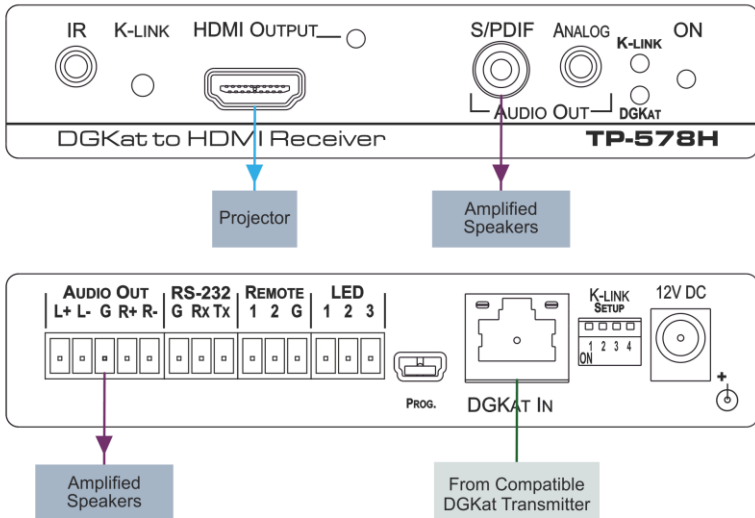

For best results, we recommend that you always use Kramer DGKat cables when connecting AV equipment to the TP-578H.

Step 4: Set the DIP-switches

#	Feature	Function	Switch State
1	Lock EDID	Locks the current EDID in memory	On—Lock EDID (down) Off—Normal EDID mode (default, up)
2	Output timeout	Turns off the output after 5 minutes when there is no input signal	On—Timeout enabled Off—Timeout disabled. Output always on
3	For future use		
4	For future use		

Step 5: Connect the power

Connect the power adapter to the **TP-578H** and plug the adapter into the mains electricity.



Contents

1	Introduction	1
2	Getting Started	2
2.1	Achieving the Best Performance	2
2.2	Safety Instructions	2
2.3	Recycling Kramer Products	3
3	Overview	4
3.1	Using TP cables	5
4	Defining the TP-578H DGKat to HDMI Receiver	6
5	Connecting the TP-578H	8
5.1	Connecting a Serial Controller to the TP-578H via RS-232	9
5.2	Connecting a Balanced/Unbalanced Stereo Audio Device	9
6	Operating the TP-578H	10
6.1	The K-Link Setup 4-way DIP-switch	10
6.2	Locking the EDID	10
6.3	Setting the Output Timeout	10
6.4	Setting the Active or Passive Data K-Link Mode	11
6.5	LED Operation	11
7	Wiring the TP RJ-45 Ethernet Connector	13
8	Technical Specifications	14
8.1	Default Communication Parameters	14
9	Default EDID	15
10	Protocol 3000	17
10.1	Kramer Protocol 3000 Syntax	17
10.2	Kramer Protocol 3000 Commands	20

Figures

Figure 1:	TP-578H DGKat to HDMI Receiver Front Panel	6
Figure 2:	TP-578H DGKat to HDMI Receiver Rear Panel	7
Figure 3:	Connecting the TP-578H DGKat to HDMI Receiver	8
Figure 4:	Balanced Stereo Audio Connection	9
Figure 5:	Unbalanced Stereo Audio Output Connection	9
Figure 6:	TP Pinout Wiring	13

1 Introduction

Welcome to Kramer Electronics! Since 1981, Kramer Electronics has been providing a world of unique, creative, and affordable solutions to the vast range of problems that confront video, audio, presentation, and broadcasting professionals on a daily basis. In recent years, we have redesigned and upgraded most of our line, making the best even better!

Our 1,000-plus different models now appear in 14 groups that are clearly defined by function: GROUP 1: Distribution Amplifiers; GROUP 2: Switchers and Routers; GROUP 3: Control Systems; GROUP 4: Format/Standards Converters; GROUP 5: Range Extenders and Repeaters; GROUP 6: Specialty AV Products; GROUP 7: Scan Converters and Scalers; GROUP 8: Cables and Connectors; GROUP 9: Room Connectivity; GROUP 10: Accessories and Rack Adapters and GROUP 11: Sierra Video Products; GROUP 12: Digital Signage; and GROUP 13: Audio, and GROUP 14: Collaboration.

Congratulations on purchasing your Kramer DigiTOOLS® **TP-578H DGK** *at to HDMI Receiver*, which is ideal for the following typical applications:

- Boardrooms and classrooms
- Multimedia applications

2 Getting Started

We recommend that you:

- Unpack the equipment carefully and save the original box and packaging materials for possible future shipment
- Review the contents of this user manual



Go to http://www.kramerelectronics.com/support/product_downloads.asp to check for up-to-date user manuals, application programs, and to check if firmware upgrades are available (where appropriate).

2.1 Achieving the Best Performance

To achieve the best performance:

- Use only good quality connection cables (we recommend Kramer DGKat, high-performance, high-resolution cables) to avoid interference, deterioration in signal quality due to poor matching, and elevated noise levels (often associated with low quality cables)
- Do not secure the cables in tight bundles or roll the slack into tight coils
- Avoid interference from neighboring electrical appliances that may adversely influence signal quality
- Position your Kramer **TP-578H DGKat to HDMI Receiver** away from moisture, excessive sunlight and dust



This equipment is to be used only inside a building. It may be connected only to other equipment that is installed inside a building.

2.2 Safety Instructions



Caution: No operator serviceable parts inside the unit

Warning: Use only the Kramer Electronics input power wall adapter that is provided with the unit.

Warning: Disconnect the power and unplug the unit from the wall before installing

2.3 Recycling Kramer Products

The Waste Electrical and Electronic Equipment (WEEE) Directive 2002/96/EC aims to reduce the amount of WEEE sent for disposal to landfill or incineration by requiring it to be collected and recycled. To comply with the WEEE Directive, Kramer Electronics has made arrangements with the European Advanced Recycling Network (EARN) and will cover any costs of treatment, recycling and recovery of waste Kramer Electronics branded equipment on arrival at the EARN facility. For details of Kramer's recycling arrangements in your particular country go to our recycling pages at <http://www.kramerelectronics.com/support/recycling/>.

3 Overview

The high quality **TP-578H DGMK to HDMI Receiver** accepts a DGMK TP (Twisted Pair) signal from a compatible Kramer DGMK transmitter and decodes it into the following signals:

- HDMI
- IR
- S/PDIF digital audio
- Balanced and unbalanced audio
- RS-232

The device is designed to be used in conjunction with any Kramer DGMK switcher or transmitter, (for example, the **WP-577VH**).

The **TP-578H** features:

- HDCP support
- HDTV compatibility
- A system range of up to 70m (230ft) at 1080p and 1600 x 1200 on shielded **BC-DGMK623** cable (see [Section 3.1](#))
- HPD—Hot Plug Detect signals from the display device to the source
- Equalization and reclocking of the data
- K-LINK compatibility
- Up to 4.95Gbps data rate (1.65Gbps per graphics channel)
- A DigiTOOLS® sized enclosure. Three devices can be mounted in a 1U rack space using the optional **RK-3T** adapter
- Lockable EDID

- PowerConnectPlus—A single connection to the transmitter or the receiver powers both units. The higher voltage PowerConnectPlus also powers regular PowerConnect devices via auto-negotiation

Note: The **TP-578H** can supply power to PowerConnect devices but can only be powered by PowerConnectPlus devices.



Warning: Using a TP cable that is incorrectly wired may cause permanent damage to the device

The **TP-578H** supports a range of:

- Up to 90m (295ft) at 1080i, or up to 30m (98ft) at 1080p on shielded **BC-DGKat524** cable
- Up to 90m (295ft) at 1080i, or up to 70m (230ft) at 1080p on shielded **BC-DGKat623** cable
- Up to 100m (330ft) at 1080i or up to 90m (295ft) at 1080p on shielded **BC-DGKat7a23** cable

Note: The transmission range depends on the signal resolution, the graphics card and the display used. The distance using non-Kramer CAT 6 and CAT 7a cables may not reach these ranges.

3.1 Using TP cables

Kramer engineers have developed special twisted pair cables to best match our digital twisted pair products; the Kramer **BC-DGKat524** (CAT 5 24 AWG), the Kramer **BC-DGKat623** (CAT 6 23 AWG), and the Kramer **BC-DGKat7a23** (CAT 7a 23 AWG) cables. These specially built cables significantly outperform regular CAT 5/CAT 6/CAT 7a cables.

Note: The **TP-578H** cannot work with unshielded cables.

4 Defining the TP-578H DGKat to HDMI Receiver

Figure 1 defines the front panel of the TP-578H.

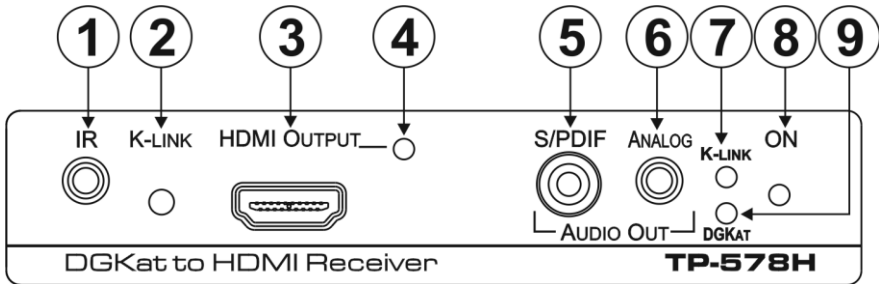

Figure 1: TP-578H DGKat to HDMI Receiver Front Panel

#	Feature	Function	
1	IR 3.5mm Mini Jack	Connect to the IR blaster or sensor	
2	K-LINK Mode Button	Press to toggle between the active and passive data modes, (see Section 6.4). The current data mode is indicated by the K-LINK LED, (see K-LINK LED)	
3	HDMI OUTPUT Connector	Connect to the HDMI acceptor, (see Section 5)	
4	HDMI OUTPUT LED	Lights green when there is a video acceptor present, (see Section 6.5.1)	
5	AUDIO OUT	S/PDIF Digital Audio RCA Connector	Connect to the digital, stereo audio acceptor
6		ANALOG Audio 3.5mm Mini Jack	Connect to the unbalanced, stereo audio acceptor
7	K-LINK LED	The LED indicates the current K-LINK data mode: <ul style="list-style-type: none"> Lights green when the device is in active data mode Lights red when the device is in passive data mode To toggle the K-Link data mode, press the K-Link button, (see K-LINK Mode Button)	
8	ON LED	The LED indicates the power supply status: <ul style="list-style-type: none"> Lights green when the device receives adequate power Flashes red/green if there is not adequate power, (see Section 6.5.2) 	
9	DGKat LED	Lights green when the DGKat link to the transmitter is valid	

Figure 2 defines the rear panel of the TP-578H.

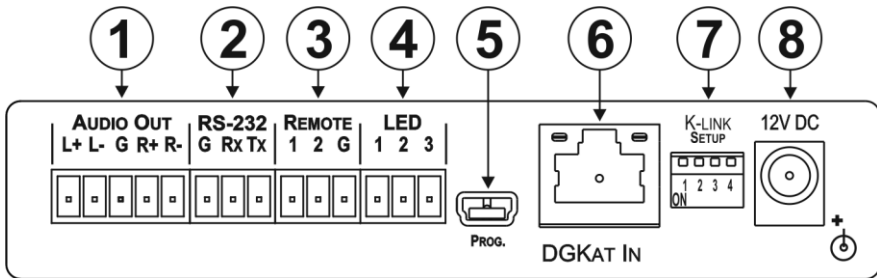

Figure 2: TP-578H DGKat to HDMI Receiver Rear Panel

#	Feature	Function
1	AUDIO OUT 5-way Terminal Block	Connect to the balanced, stereo audio acceptor (see Section 5.2)
2	RS-232 3-way Serial Terminal Block	Connect to the RS-232 serial transmitter or receiver. Note: Data is transmitted even in the absence of a video or audio signal (see Section 6.4)
3	REMOTE 3-way Terminal Block	For future use
4	LED 3-way Terminal Block	For future use
5	PROG. Mini USB Connector	For the use of Kramer service personnel only
6	DGKat IN RJ-45 TP Connector	Connect to a compatible DGKat TP switcher/transmitter (for example, the WP-577VH)
7	K-Link SETUP 4-way DIP-switch	For setting device functions, (see Section 6.1)
8	12V DC Connector	Connect to the power adapter, center pin positive

5 Connecting the TP-578H



Always disconnect/switch off the power to all devices before connecting them to your **TP-578H**. After connecting your **TP-578H**, connect its power and then reconnect/switch on the power to the other devices.

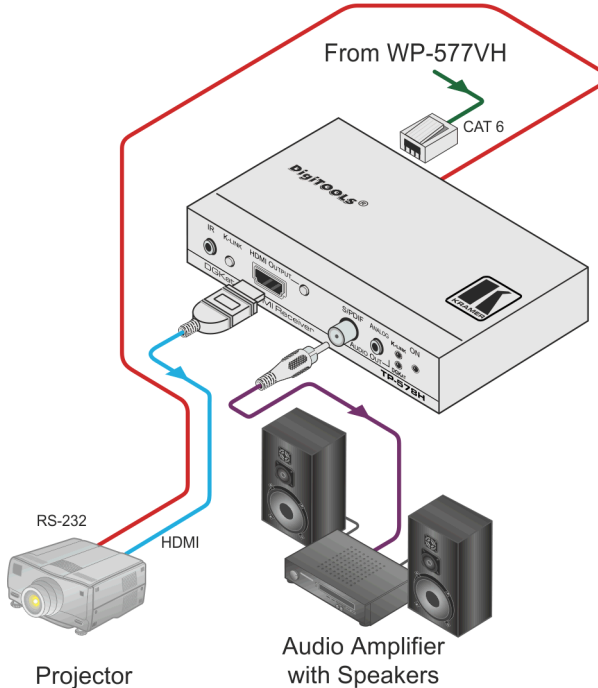

Figure 3: Connecting the TP-578H DKGat to HDMI Receiver

To connect the TP-578H as illustrated in the example in [Figure 3](#):

1. Connect the DKGat Out RJ-45 connector on the **WP-577VH** to the DKGat In RJ-45 connector on the **TP-578H** using STP cable (see [Section 3.1](#)).
2. Connect the HDMI Output on the **TP-578H** to the HDMI acceptor, (for example, a projector).
3. Connect the RS-232 3-way terminal block on the **TP-578H** to the RS-232 controlled device, (for example, a projector).

4. Connect the Audio Out S/PDIF digital, RCA audio connector on the **TP-578H** to the audio acceptor, (for example, an audio amplifier with speakers).
5. Connect the power adapter to the **TP-578H** and to the mains electricity (not shown in [Figure 3](#)).

5.1 Connecting a Serial Controller to the TP-578H via RS-232

To connect a serial controller to the **TP-578H**:

- From the RS-232 9-pin D-sub serial port on the serial controller connect:
 - Pin 5 to the GND pin on the **TP-578H** RS-232 terminal block
 - Pin 3 to the RX pin on the **TP-578H** RS-232 terminal block
 - Pin 2 to the TX pin on the **TP-578H** RS-232 terminal block

5.2 Connecting a Balanced/Unbalanced Stereo Audio Device

[Figure 4](#) and [Figure 5](#) illustrate how to connect a balanced and unbalanced stereo audio device to the Audio Out 5-way terminal block.

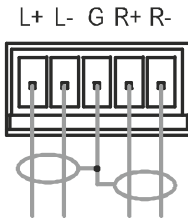

Figure 4: Balanced Stereo Audio Connection

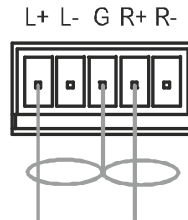

Figure 5: Unbalanced Stereo Audio Output Connection

6 Operating the TP-578H

6.1 The K-Link Setup 4-way DIP-switch

The Setup 4-way dip-switch lets you lock the EDID and set the output timeout. When a switch is down it is on and when it is up it is off.

Switch #	Feature	Function	Switch State
1	Lock EDID	Locks the current EDID in memory	On—Lock EDID (down) Off—Normal EDID mode (Default, up)
2	Output timeout	Turns off the output after 300 seconds when there is no input signal	On—Timeout enabled Off—Timeout disabled. Output always on
3	For future use		
4			

6.2 Locking the EDID

You can lock the current EDID to prevent the EDID from being updated automatically when a new display device is plugged in.

To lock the current EDID:

- Set DIP-switch 1 to ON

Note: You can only modify the EDID using Protocol 3000 commands or the EDID Designer when DIP-switch 1 is on.

6.3 Setting the Output Timeout

You can set the output to be disabled when there is no input detected for 5 minutes or to be always on.

To enable the timeout:

- Set DIP-switch 2 to ON

6.4 Setting the Active or Passive Data K-Link Mode

Note: Data is transmitted even in the absence of video and audio signals.

The **TP-578H** treats RS-232 data in either of the following manners:

- Active—The data are treated as Kramer Protocol 3000 commands and are processed by the microcontroller of the **TP-578H**
- Passive—The data is treated as raw data and is transmitted over the DGKat link with no processing

To select the active or passive data mode:

- Press the K-Link mode button to toggle between the active and passive data modes.

When the K-Link LED on the front panel lights green, the device is in the active mode. When the K-Link LED lights red, the device is in the passive mode.

6.5 LED Operation

The LEDs on the front panel provide status information as detailed below.

6.5.1 HDMI Output LED

HDMI Output LED Color	HDMI Signal State
Solid green	There is a video acceptor
Flashes green for a few seconds, then lights solid green	There is an acceptor connected but it does not support HDCP
Off	No video acceptor connected

6.5.2 DGKat LED

DGKat LED Color	DGKat State
Solid green	Valid DGKat link with a video signal
Flashing green	There is a DGKat link but no video signal
Off	The DGKat link is not valid

6.5.1 K-Link LED

K-Link LED Color	K-Link Mode
Red	Passive mode
Green	Active mode

6.5.2 On LED

On LED Color	Power Status
Green	Power is connected
Flashes green/red	The device is negotiating the power requirement

7 Wiring the TP RJ-45 Ethernet Connector

Connect/solder the cable shield to the RJ-45 connector shield at both ends of the cable.



Do not use a crossed TP cable with this product.

Using a TP cable that is incorrectly wired may cause permanent damage to the device.

Do not use unshielded TP cables with this product.

[Figure 6](#) defines the TP pinout using a straight pin-to-pin cable with RJ-45 connectors.

EIA /TIA 568B	
PIN	Wire Color
1	Orange / White
2	Orange
3	Green / White
4	Blue
5	Blue / White
6	Green
7	Brown / White
8	Brown
Pair 1	4 and 5
Pair 2	1 and 2
Pair 3	3 and 6
Pair 4	7 and 8

Figure 6: TP Pinout Wiring

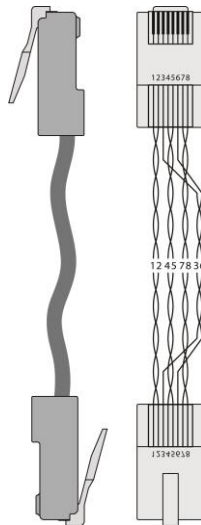

8 Technical Specifications

INPUTS:	1 DGKat TP on an RJ-45 connector
OUTPUTS:	1 HDMI on an HDMI connector 1 S/PDIF digital audio on an RCA connector 1 Analog unbalanced stereo audio on a 3.5mm mini jack 1 Analog balanced stereo audio on a 5-way terminal block
PORTS:	1 RS-232 serial port on a 3-way terminal block 1 IR port on a 3.5mm mini jack
BANDWIDTH:	Up to 4.95Gbps data rate (1.65Gbps per graphics channel)
COMPLIANCE WITH HDCP STANDARD:	Supports HDCP
INDICATOR LEDs:	HDMI OUTPUT, K-LINK, DGKAT, Power
POWER CONSUMPTION:	12V DC, 900mA
OPERATING TEMPERATURE:	0° to +40°C (32° to 104°F)
STORAGE TEMPERATURE:	-40° to +70°C (-40° to 158°F)
HUMIDITY:	10% to 90%, RHL non-condensing
DIMENSIONS:	12.1cm x 6.99cm x 2.47cm (4.76" x 2.75" x 0.97") W, D, H
WEIGHT:	0.35kg (0.77lbs) approx.
INCLUDED ACCESSORIES:	Power supply
OPTIONS:	RK-3T 19" rack adapter
Specifications are subject to change without notice at http://www.kramerelectronics.com	

8.1 Default Communication Parameters

RS-232	
Protocol 3000	
Baud Rate:	115,200
Data Bits:	8
Stop Bits:	1
Parity:	None
Command Format:	ASCII

9 Default EDID

Monitor

Model name..... TP-578H
Manufacturer..... KMR
Plug and Play ID..... KMR1200
Serial number..... 505-709990100
Manufacture date..... 2011, ISO week 255
Filter driver..... None

EDID revision..... 1.3
Input signal type..... Digital
Color bit depth..... Undefined
Display type..... Monochrome/grayscale
Screen size..... 520 x 320 mm (24.0 in)
Power management..... Standby, Suspend, Active off/sleep
Extension blocs..... 1 (CEA-EXT)

DDC/CI..... n/a

Color characteristics

Default color space..... Non-sRGB
Display gamma..... 2.20
Red chromaticity..... Rx 0.674 - Ry 0.319
Green chromaticity..... Gx 0.188 - Gy 0.706
Blue chromaticity..... Bx 0.148 - By 0.064
White point (default)... Wx 0.313 - Wy 0.329
Additional descriptors... None

Timing characteristics

Horizontal scan range.... 30-83kHz
Vertical scan range..... 56-76Hz
Video bandwidth..... 170MHz
CVT standard..... Not supported
GTF standard..... Not supported
Additional descriptors... None
Preferred timing..... Yes
Native/preferred timing.. 1280x720p at 60Hz (16:10)
Modeline..... "1280x720" 74.250 1280 1390 1430 1650 720 725 730 750 +hsync +vsync

Standard timings supported

720 x 400p at 70Hz - IBM VGA
720 x 400p at 88Hz - IBM XGA2
640 x 480p at 60Hz - IBM VGA
640 x 480p at 67Hz - Apple Mac II
640 x 480p at 72Hz - VESA
640 x 480p at 75Hz - VESA
800 x 600p at 56Hz - VESA
800 x 600p at 60Hz - VESA
800 x 600p at 72Hz - VESA
800 x 600p at 75Hz - VESA
832 x 624p at 75Hz - Apple Mac II
1024 x 768i at 87Hz - IBM
1024 x 768p at 60Hz - VESA
1024 x 768p at 70Hz - VESA
1024 x 768p at 75Hz - VESA
1280 x 1024p at 75Hz - VESA
1152 x 870p at 75Hz - Apple Mac II
1280 x 1024p at 75Hz - VESA STD
1280 x 1024p at 85Hz - VESA STD
1600 x 1200p at 60Hz - VESA STD
1024 x 768p at 85Hz - VESA STD
800 x 600p at 85Hz - VESA STD
640 x 480p at 85Hz - VESA STD
1152 x 864p at 70Hz - VESA STD
1280 x 960p at 60Hz - VESA STD

EIA/CEA-861 Information

Revision number..... 3

10 Protocol 3000

The **TP-578H** can be operated using serial commands from a PC, remote controller or touch screen using the Kramer Protocol 3000.

This section describes the:

- Kramer Protocol 3000 syntax (see [Section 10.1](#))
- Kramer Protocol 3000 commands (see [Section 10.2](#))

10.1 Kramer Protocol 3000 Syntax

10.1.1 Host Message Format

Start	Address (optional)	Body	Delimiter
#	<i>device_id@</i>	Message	CR

10.1.1.1 Simple Command

Command string with only one command without addressing:

Start	Body	Delimiter
#	Command SP <i>Parameter_1,Parameter_2,...</i>	CR

10.1.1.2 Command String

Formal syntax with command concatenation and addressing:

Start	Address	Body	Delimiter
#	<i>device_id@</i>	Command_1 <i>Parameter1_1,Parameter1_2,...</i> Command_2 <i>Parameter2_1,Parameter2_2,...</i> Command_3 <i>Parameter3_1,Parameter3_2,...</i>	CR

10.1.2 Device Message Format

Start	Address (optional)	Body	delimiter
~	<i>device_id@</i>	Message	CR LF

10.1.2.1 Device Long Response

Echoing command:

Start	Address (optional)	Body	Delimiter
~	<i>device_id@</i>	Command SP [<i>Param1 ,Param2 ...</i>] result	CR LF

CR = Carriage return (ASCII 13 = 0x0D)

LF = Line feed (ASCII 10 = 0x0A)

SP = Space (ASCII 32 = 0x20)

10.1.3 Command Terms

Command

A sequence of ASCII letters ('A'-'Z', 'a'-'z' and '-').

Command and parameters must be separated by at least one space.

Parameters

A sequence of alphanumeric ASCII characters ('0'-'9', 'A'-'Z', 'a'-'z' and some special characters for specific commands). Parameters are separated by commas.

Message string

Every command entered as part of a message string begins with a **message starting character** and ends with a **message closing character**.

Note: A string can contain more than one command. Commands are separated by a pipe ('|') character.

Message starting character

'#' – For host command/query

'~' – For device response

Device ID (Optional, for K-NET)

K-NET Device ID followed by '@'

Query sign

'?' follows some commands to define a query request.

Message closing character

CR – For host messages; carriage return (ASCII 13)

CRLF – For device messages; carriage return (ASCII 13) + line-feed (ASCII 10)

Command chain separator character

When a message string contains more than one command, a pipe ('|') character separates each command.

Spaces between parameters or command terms are ignored.

10.1.4 Entering Commands

You can directly enter all commands using a terminal with ASCII communications software, such as HyperTerminal, Hercules, etc. Connect the terminal to the serial or Ethernet port on the Kramer device. To enter **CR** press the Enter key. (**LF** is also sent but is ignored by command parser).

For commands sent from some non-Kramer controllers like Crestron, some characters require special coding (such as, /X##). Refer to the controller manual.

10.1.5 Command Forms

Some commands have short name syntax in addition to long name syntax to allow faster typing. The response is always in long syntax.

10.1.6 Chaining Commands

Multiple commands can be chained in the same string. Each command is delimited by a pipe character (“|”). When chaining commands, enter the **message starting character** and the **message closing character** only once, at the beginning of the string and at the end.

Commands in the string do not execute until the closing character is entered.

A separate response is sent for every command in the chain.

10.1.7 Maximum String Length

64 characters

10.2 Kramer Protocol 3000 Commands

Command	Description
#	Protocol handshaking
BUILD-DATE?	Read device build date
CPEDID	Copy EDID data from the output to the input EEPROM
DEF-RES?	Assign custom defined scaled video output resolution to “vic” index
DISPLAY?	Read if output is valid
GEDID	Read EDID data
HDCP-STAT?	Get HDCP signal status
HELP	List of commands
KLINK_INF	Set K-Link MCU direct mode
KLINK_CLS	Set K-Link data mode
LDEDID	Load EDID data
LDFW	Load new firmware
MODEL?	Read device model
NAME?	Get machine (DNS) name
PROT-VER?	Read device protocol version
RESET	Reset device
SIGNAL?	Read if input is valid
SN?	Read device serial number
UPGRADE	Execute firmware upgrade
VERSION?	Read device firmware version

Command - #		Command Type - System-mandatory	
Command Name		Permission	Transparency
Set:	#	End User	Public
Get:	-	-	-
Description		Syntax	
Set:	Protocol handshaking	#	
Get:	-	-	-
Response			
~nn@SPOK _{CR LF}			
Parameters			
Response Triggers			
Notes			
Use to validate the Protocol 3000 connection and get the machine number			

Command - BUILD-DATE		Command Type - System-mandatory	
Command Name		Permission	Transparency
Set:	-	-	-
Get:	BUILD-DATE?	End User	Public
Description		Syntax	
Set:	Get device build date	# BUILD-DATE _{CR}	
Get:	-	-	
Response			
~ hn @ BUILD-DATE _{SP} date _{SP} time _{CR LF}			
Parameters			
<i>date</i> - Format: YYYY/MM/DD where YYYY = Year, MM = Month, DD = Day			
<i>time</i> - Format: hh:mm:ss where hh = hours, mm = minutes, ss = seconds			
Response Triggers			
Notes			

Command - CPEDID		Command Type - System	
Command Name		Permission	Transparency
Set:	CPEDID	End User	Public
Get:	-	-	-
Description		Syntax	
Set:	Copy EDID data from the output to the input EEPROM	# CPEDID _{SP} src_type, src_id, dst_type, dest_bitmap _{CR}	
Get:	-	-	
Response			
~ hn @ CPEDID _{SP} src_stg, src_id, dst_type, dest_bitmap _{CR LF}			
Parameters			
<i>src_type</i> - EDID source type (usually output)			
<i>src_id</i> - number of chosen source stage (1.. max number of inputs/outputs)			
<i>dst_type</i> - EDID destination type (usually input) (see Section 10.2.12)			
<i>dest_bitmap</i> - bitmap representing destination IDs. Format: XXXX...X, where X is hex digit. The binary form of every hex digit represents corresponding destinations. Setting '1' says that EDID data has to be copied to this destination			
Response Triggers			
Response is sent to the com port from which the Set was received (before execution)			
Notes			
Destination bitmap size depends on device properties (for 64 inputs it is a 64-bit word) Example: bitmap 0x0013 means inputs 1,2 and 5 are loaded with the new EDID			

Command - DEF-RES		Command Type - Video	
Command Name		Permission	Transparency
Set	DEF-RES	Administrator	Public
Get	DEF-RES?	End User	Public
Description		Syntax	
Set:	Set custom defined scaled video output resolution to "vic" index	#DEF-RES _{SP} Table_id,Width,Height,Htotal,VTTotal,HSyncW,HSyncBackPorch,VSyncW,VSyncBackPorch,FrRate,Interlaced _{CR}	
Get:	Get custom defined video resolution	#DEF-RES? _{SP} VIC_id, stage, stage_id _{CR}	
Response			
~ nn@DEF-RES _{SP} Table_id,Width,Height,Htotal,VTTotal,HSyncW,HSyncBackPorch,VSyncW,VSyncBackPorch,FrRate,Interlaced _{CR LF}			
Parameters			
<i>Table_id</i> - index in resolution table (see Section 10.2.3 Video Resolutions). Valid indexes for SET are 100-104 only <i>Custom resolution parameters</i> - by name (self-explanatory), numeric value <i>Interlaced</i> - interlaced/progressive according to Section 10.2.1 On/Off ("ON"- I, "OFF" - P) <i>Stage</i> - input/output <i>Stage_id</i> - number of chosen stage (1...max number of inputs/outputs)			
Response Triggers			
After execution, response is sent to the com port from which the Set/Get was received After execution, response is sent to all com ports if DEF-RES was set by any other external control device (button press, device menu and similar)			
Notes			
If a requested custom resolution is not defined, yet is in the device, it returns ERR _{SP} 003 (out of range) Only indexes 100-104 are valid for custom defined resolution In Get command when sending: index 0 - device replies with detailed info of native resolution index 255 - device replies with detailed info of current resolution			

Command - DISPLAY?		Command Type - System	
Command Name		Permission	Transparency
Set:	-	-	-
Get	DISPLAY?	End User	Public
Description		Syntax	
Set:	-	-	
Get:	Get output HPD status	# DISPLAY? _{SP} <i>out_id</i> _{CR}	
Response			
~ _{CR} @ DISPLAY? _{SP} <i>out_id,status</i> _{CR LF}			
Parameters			
<i>out_id</i> - output number			
<i>status</i> - HPD status according to signal validation			
Response Triggers			
After execution, response is sent to the com port from which the Get was received			
Response is sent after every change in output HPD status ON to OFF			
Response is sent after every change in output HPD status OFF to ON and ALL parameters (new EDID, etc.) are stable and valid			
Notes			

Command - GEDID		Command Type - System	
Command Name		Permission	Transparency
Set:	GEDID	Administrator	Public
Get:	GEDID?	End User	Public
Description		Syntax	
Set:	Set EDID data from device	# GEDID _{SP} <i>stage, stage_id</i> _{CR}	
Get:	Get EDID support on certain input/output	# GEDID? _{SP} <i>stage, stage_id</i> _{CR}	
Response			
Set:			
Multi-line response:			
~ _{nn} @ GEDID _{SP} <i>stage,stage_id,size</i> _{CR LF}			
EDID_data _{CR LF}			
~ _{nn} @ GEDID _{SP} <i>stage,stage_id</i> _{SP} OK _{CR LF}			
Get:			
~ _{nn} @ GEDID _{SP} <i>stage,stage_id,size</i> _{CR LF}			
Parameters			
<i>stage</i> - input/output			
<i>stage_id</i> - number of chosen stage (1.. max number of inputs/outputs)			
<i>size</i> - EDID data size. For Set, size of data to be sent from device, for Get, 0 means no EDID support			
Response Triggers			
Response is sent to the com port from which the Set (before execution) / Get command was received			
Notes			
For Get, size=0 means EDID is not supported			
For old devices that do not support this command, ~ _{nn} @ ERR 002 _{CR LF} is received			

Command - HDCP-STAT		Command Type - System	
Command Name		Permission	Transparency
Set:	-	-	-
Get:	HDCP-STAT?	End User	Public
Description		Syntax	
Set:	None	-	
Get:	Get HDCP signal status	# HDCP-STAT? _[SP] <i>stage,stage_id</i> _[CR]	
Response			
Set / Get: ~ _[nn] @ HDCP-STAT _[SP] <i>stage,stage_id,mode</i> _[CR LF]			
Parameters			
<i>stage</i> – input/output			
<i>stage_id</i> - number of chosen stage (1.. max number of inputs/outputs)			
<i>actual_status</i> - signal encryption status - valid values ON/OFF			
Response Triggers			
Response is sent to the com port from which the Set (before execution) / Get command was received			
Response is sent to all com ports after execution if HDCP-STAT was set by any other external control device (button press, device menu and similar) or HDCP mode changed			
Notes			

Command - HELP		Command Type - System-mandatory	
Command Name		Permission	Transparency
Set:	-	-	-
Get:	HELP	End User	Public
Description		Syntax	
Set:	-	-	
Get:	Get command list or help for specific command	2 options: 1. # HELP _[CR] 2. # HELP _[SP] <i>command_name</i> _[CR]	
Response			
1. Multi-line: ~ _[nn] @ Device available protocol 3000 commands: _[CR LF] <i>command</i> _[SP] <i>command...</i> _[CR LF]			
To get help for command use: HELP (COMMAND_NAME) _[CR LF]			
2. Multi-line: ~ _[nn] @ HELP _[SP] <i>command:</i> _[CR LF] <i>description</i> _[CR LF] USAGE: <i>usage</i> _[CR LF]			
Parameters			
Response Triggers			
Notes			

Command – KLINK_INF		Command Type – System	
Command Name		Permission	Transparency
Set:	KLINK_INF	Admin	Internal
Get:	-	-	-
Description		Syntax	
Set:	Set K-Link MCU direct mode (DGKat only)	# KLINK_INF <input type="checkbox"/>	
Get :	-	-	
Response			
~ <input type="checkbox"/> @ KLINK_INF <input type="checkbox"/>			
Parameters			
None			
Response Triggers			
After receiving KLINK_INF command over DGCat			

Command – KLINK_CLS		Command Type – System	
Command Name		Permission	Transparency
Set:	KLINK_CLS	Admin	Internal
Get:	-	-	-
Description		Syntax	
Set:	Set K-Link data mode (DGKat only)	# KLINK_CLS <input type="checkbox"/>	
Get:	-	-	
Response			
KLNK_ACK <input type="checkbox"/> <small>CR LF</small>			
Parameters			
None			
Response Triggers			
Under receiving KLINK_CLS command over DGKat/RS-232			
Notes			

Command - LDEDID		Command Type - System	
Command Name		Permission	Transparency
Set:	LDEDID	End User	Public
Get:	-	-	-
Description		Syntax	
Set:	Write EDID data from external application to device	Multi-step syntax (see following steps)	
Get:	None	None	
Communication Steps (Command and Response)			
<p>Step 1: #LDEDID_[SP]<i>dst_type, dest_bitmask, size, safe_mode</i>_[CR]</p> <p>Response 1: -nn@LDEDID_[SP]<i>dst_type, dest_bitmask, size, safe_mode</i>_[SP]READY_[CR LF] or -nn@LDEDID_[SP]ERRnn_[CR LF]</p> <p>Step 2: If ready was received, send EDID_DATA</p> <p>Response 2: -nn@LDEDID_[SP]<i>dst_type, dest_bitmask, size, safe_mode</i>_[SP]OK_[CR LF] or -nn@LDEDID_[SP]ERRnn_[CR LF]</p>			
Parameters			
<p><i>dst_type</i> - EDID destination type (usually input)</p> <p><i>dest_bitmask</i> - bitmap representing destination IDs. Format: 0x*****, where * is ASCII presentation of hex digit. The binary presentation of this number is a bit mask for destinations. Setting '1' means EDID data has to be copied to this destination</p> <p><i>size</i> - EDID data size</p> <p><i>safe_mode</i> - 0 - Device accepts the EDID as is without trying to adjust 1 - Device tries to adjust the EDID</p> <p>EDID_DATA - data in protocol packets</p>			
Response Triggers			
Response is sent to the com port from which the Set (before execution)			
Notes			
<p>When the unit receives the LDEDID command it replies with READY and enters the special EDID packet wait mode. In this mode the unit can receive only packets and not regular protocol commands.</p> <p>If the unit does not receive correct packets for 30 seconds or is interrupted for more than 30 seconds before receiving all packets, it sends timeout error -nn@LDEDID_[SP]ERR01_[CR LF] and returns to the regular protocol mode. If the unit received data that is not a correct packet, it sends the corresponding error and returns to the regular protocol mode.</p>			

Command - LDWF		System - Packets	
Command Name		Permission	Transparency
Set:	LDWF	Internal SW	Public
Get:	-	-	-
Description		Syntax	
Set:	Load new firmware file	Step 1: # LDWF _{SP} size _{CR} Step 2: If ready was received, send FIRMWARE_DATA	
Get:	-	-	
Response			
Response 1: ~ nn @ LDWF _{SP} size _{SP} READY _{CR LF} or ~ nn @ LDWF _{SP} ERRnn _{CR LF}			
Response 2: ~ nn @ LDWF _{SP} size _{SP} OK _{CR LF}			
Parameters			
size - size of firmware data that is sent			
FIRMWARE_DATA - HEX or KFW file in protocol packets, (see Section 10.2.14)			
Response Triggers			
Notes			
In most devices firmware data is saved to flash memory, but the memory does not update until receiving the "UPGRADE" command and is restarted, (See Section 10.2.6)			

Command - MODEL?		Command Type - System-mandatory	
Command Name		Permission	Transparency
Set:	-	-	-
Get:	MODEL?	End User	Public
Description		Syntax	
Set:	-	-	
Get:	Get device model	# MODEL? _{CR}	
Response			
~ nn @ MODEL _{SP} model_name _{CR LF}			
Parameters			
model_name - String of up to 19 printable ASCII chars			
Response Triggers			
Notes			

Command – NAME?		Command Type - System (Ethernet)	
Command Name		Permission	Transparency
Get:	NAME?	End User	Public
Description		Syntax	
Set:	Set machine (DNS) name	# NAME _{SP} machine_name _{CR}	
Get:	Get machine (DNS) name	# NAME? _{CR}	
Response			
Set: - _{nn} @ NAME _{SP} machine_name _{SP} OK _{CR LF}			
Get: - _{nn} @ NAME? _{SP} machine_name _{CR LF}			
Parameters			
machine_name - String of up to 14 alpha-numeric chars (can include hyphen, not at the beginning or end)			
Response Triggers			
Notes			
The machine name is not the same as the model name. The machine name is used to identify a specific machine or a network in use (with DNS feature on)			

Command - PROT-VER?		Command Type - System-mandatory	
Command Name		Permission	Transparency
Set:	-	-	-
Get:	PROT-VER?	End User	Public
Description		Syntax	
Set:	-	-	
Get:	Get device protocol version	# PROT-VER? _{CR}	
Response			
- _{nn} @ PROT-VER _{SP} 3000:version _{CR LF}			
Parameters			
Version - XX.XX where X is a decimal digit			
Response Triggers			
Notes			

Command - RESET		Command Type - System-mandatory	
Command Name		Permission	Transparency
Set:	RESET	Administrator	Public
Get:	-	-	-
Description		Syntax	
Set:	Reset device	# RESET <input type="checkbox"/> _CR	
Get:	-	-	
Response			
~nn@ RESET <input type="checkbox"/> _SP OK <input type="checkbox"/> _CR_LF			
Parameters			
Response Triggers			
Notes			
To avoid locking the port due to a USB bug in Windows, disconnect USB connections immediately after running this command. If the port was locked, disconnect and reconnect the cable to reopen the port.			

Command - SIGNAL		Command Type - System	
Command Name		Permission	Transparency
Set:	-	-	-
Get	SIGNAL?	End User	Public
Description		Syntax	
Set:	-	-	
Get:	Get input signal lock status	# SIGNAL? <input type="checkbox"/> _SPinp_id <input type="checkbox"/> _CR	
Response			
~nn@ SIGNAL <input type="checkbox"/> _SPinp_id,status <input type="checkbox"/> _CR_LF			
Parameters			
inp_id - input number status - lock status according to signal validation, (see Section 10.2.5)			
Response Triggers			
After execution, a response is sent to the com port from which the Get was received Response is sent after every change in input signal status ON to OFF, or OFF to ON			
Notes			

Command - SN?		Command Type - System-mandatory	
Command Name		Permission	Transparency
Set:	-	-	-
Get:	SN?	End User	Public
Description		Syntax	
Set:	-	-	
Get:	Get device serial number	# SN? <input type="checkbox"/> CR	
Response			
- <input type="checkbox"/> hn@ SN <input type="checkbox"/> SP serial_number <input type="checkbox"/> CR LF			
Parameters			
serial_number - 11 decimal digits, factory assigned			
Response Triggers			
Notes			
For new products with 14 digit serial numbers, use only the last 11 digits			

Command - UPGRADE		Command Type - System	
Command Name		Permission	Transparency
Set:	UPGRADE	Administrator	Internal
Get:	-	-	-
Description		Syntax	
Set:	Perform firmware upgrade	# UPGRADE <input type="checkbox"/> CR	
Get:	-	-	
Response			
- <input type="checkbox"/> hn@UPGRADE <input type="checkbox"/> SP OK <input type="checkbox"/> CR LF			
Parameters			
Response Triggers			
Notes			
<p>Not necessary for some devices</p> <p>Firmware usually uploads to a device via a command like LDFW</p> <p>Reset the device to complete the process</p>			

Command - VERSION?		Command Type - System-mandatory	
Command Name		Permission	Transparency
Set:	-	-	-
Get:	VERSION?	End User	Public
Description		Syntax	
Set:	-	-	
Get:	Get firmware version number	# VERSION? _{CR}	
Response			
- _{nn} @ VERSION? _{SP} firmware_version _{CR LF}			
Parameters			
firmware_version - XX.XX.XXXX where the digit groups are: major.minor.build version			
Response Triggers			
Notes			

10.2.1 On/Off

Number	Value
0	Off
1	On

10.2.2 Stage

Number	Value
0	Input
1	Output
2	(Reserved)
3	(Reserved)

10.2.3 Video Resolutions

VIC Number	Resolution
0	No Signal (for input) / Native - EDID (for output)
1	640x480p @59.94Hz/60Hz
2	720x480p @59.94Hz/60Hz
3	720x480p @59.94Hz/60Hz
4	1280x720p @59.94Hz/60Hz
5	1920x1080i @59.94Hz/60Hz
6	720(1440)x480i @59.94Hz/60Hz
7	720(1440)x480i @59.94Hz/60Hz
8	720(1440)x240p @59.94Hz/60Hz
9	720(1440)x240p @59.94Hz/60Hz
10	2880x480i @59.94Hz/60Hz
11	2880x480i @59.94Hz/60Hz
12	2880x240p @59.94Hz/60Hz
13	2880x240p @59.94Hz/60Hz
14	1440x480p @59.94Hz/60Hz
15	1440x480p @59.94Hz/60Hz
16	1920x1080p @59.94Hz/60Hz
17	720x576p @50Hz
18	720x576p @50Hz
19	1280x720p @50Hz
20	1920x1080i @50Hz
21	720(1440)x576i @50Hz
22	720(1440)x576i @50Hz
23	720(1440)x288p @50Hz
24	720(1440)x288p @50Hz
25	2880x576i @50Hz
26	2880x576i @50Hz
27	2880x288p @50Hz
28	2880x288p @50Hz
29	1440x576p @50Hz
30	1440x576p @50Hz
31	1920x1080p @50Hz
32	1920x1080p @23.97Hz/24Hz
33	1920x1080p @25Hz
34	1920x1080p @29.97Hz/30Hz
35	2880x480p @59.94Hz/60Hz
36	2880x480p @59.94Hz/60Hz
37	2880x576p @50Hz
38	2880x576p @50Hz
39	1920x1080i @50Hz

VIC Number	Resolution
40	1920x1080i @ 100Hz
41	1280x720p @ 100Hz
42	720x576p @ 100Hz
43	720x576p @ 100Hz
44	720(1440)x576i @ 100Hz
45	720(1440)x576i @ 100Hz
46	1920x1080i @ 119.88/120Hz
47	1280x720p @ 119.88/120Hz
48	720x480p @ 119.88/120Hz
49	720x480p @ 119.88/120Hz
50	720(1440)x480i @ 119.88/120Hz
51	720(1440)x480i @ 119.88/120Hz
52	720x576p @ 200Hz
53	720x576p @ 200Hz
54	720(1440)x576i @ 200Hz
55	720(1440)x576i @ 200Hz
56	720x480p @ 239.76/240Hz
57	720x480p @ 239.76/240Hz
58	720(1440)x480i @ 239.76/240Hz
59	720(1440)x480i @ 239.76/240Hz
60	1280x720p @ 23.97Hz/24Hz
61	1280x720p @ 25Hz
62	1280x720p @ 29.97Hz/30Hz
63	1920x1080p @ 119.88/120Hz
64	1920x1080p @ 100Hz
65-100	(Reserved)
100	Custom resolution 1
101	Custom resolution 2
102	Custom resolution 3
103	Custom resolution 4
104	Custom resolution 5
104-254	(Reserved)

10.2.4 EDID Source

Number	Value
0	Input
1	Output
2	Default EDID

10.2.5 Signal Validation

Number	Value
0	Signal or sink is not valid
1	Signal or sink is valid
2	Sink and EDID is valid

10.2.6 Ethernet Port Types

Number	Value
0	TCP
1	UDP

LIMITED WARRANTY

The warranty obligations of Kramer Electronics for this product are limited to the terms set forth below:

What is Covered

This limited warranty covers defects in materials and workmanship in this product.

What is Not Covered

This limited warranty does not cover any damage, deterioration or malfunction resulting from any alteration, modification, improper or unreasonable use or maintenance, misuse, abuse, accident, neglect, exposure to excess moisture, fire, improper packing and shipping (such claims must be presented to the carrier), lightning, power surges, or other acts of nature. This limited warranty does not cover any damage, deterioration or malfunction resulting from the installation or removal of this product from any installation, any unauthorized tampering with this product, any repairs attempted by anyone unauthorized by Kramer Electronics to make such repairs, or any other cause which does not relate directly to a defect in materials and/or workmanship of this product. This limited warranty does not cover cartons, equipment enclosures, cables or accessories used in conjunction with this product.

Without limiting any other exclusion herein, Kramer Electronics does not warrant that the product covered hereby, including, without limitation, the technology and/or integrated circuit(s) included in the product, will not become obsolete or that such items are or will remain compatible with any other product or technology with which the product may be used.

How Long Does this Coverage Last

Seven years as of this printing; please check our Web site for the most current and accurate warranty information.

Who is Covered

Only the original purchaser of this product is covered under this limited warranty. This limited warranty is not transferable to subsequent purchasers or owners of this product.

What Kramer Electronics will do

Kramer Electronics will, at its sole option, provide one of the following three remedies to whatever extent it shall deem necessary to satisfy a proper claim under this limited warranty:

1. Elect to repair or facilitate the repair of any defective parts within a reasonable period of time, free of any charge for the necessary parts and labor to complete the repair and restore this product to its proper operating condition. Kramer Electronics will also pay the shipping costs necessary to return this product once the repair is complete.
2. Replace this product with a direct replacement or with a similar product deemed by Kramer Electronics to perform substantially the same function as the original product.
3. Issue a refund of the original purchase price less depreciation to be determined based on the age of the product at the time remedy is sought under this limited warranty.

What Kramer Electronics will not do Under This Limited Warranty

If this product is returned to Kramer Electronics or the authorized dealer from which it was purchased or any other party authorized to repair Kramer Electronics products, this product must be insured during shipment, with the insurance and shipping charges prepaid by you. If this product is returned uninsured, you assume all risks of loss or damage during shipment. Kramer Electronics will not be responsible for any costs related to the removal or re-installation of this product from or into any installation. Kramer Electronics will not be responsible for any costs related to any setting up this product, any adjustment of user controls or any programming required for a specific installation of this product.

How to Obtain a Remedy under this Limited Warranty

To obtain a remedy under this limited warranty, you must contact either the authorized Kramer Electronics reseller from whom you purchased this product or the Kramer Electronics office nearest you. For a list of authorized Kramer Electronics resellers and/or Kramer Electronics authorized service providers, please visit our web site at www.kramerelectronics.com or contact the Kramer Electronics office nearest you.

In order to pursue any remedy under this limited warranty, you must possess an original, dated receipt as proof of purchase from an authorized Kramer Electronics reseller. If this product is returned under this limited warranty, a return authorization number, obtained from Kramer Electronics, will be required. You may also be directed to an authorized reseller or a person authorized by Kramer Electronics to repair the product.

If it is decided that this product should be returned directly to Kramer Electronics, this product should be properly packed, preferably in the original carton, for shipping. Cartons not bearing a return authorization number will be refused.

Limitation on Liability

THE MAXIMUM LIABILITY OF KRAMER ELECTRONICS UNDER THIS LIMITED WARRANTY SHALL NOT EXCEED THE ACTUAL PURCHASE PRICE PAID FOR THE PRODUCT. TO THE MAXIMUM EXTENT PERMITTED BY LAW, KRAMER ELECTRONICS IS NOT RESPONSIBLE FOR DIRECT, SPECIAL, INCIDENTAL OR CONSEQUENTIAL DAMAGES RESULTING FROM ANY BREACH OF WARRANTY OR CONDITION, OR UNDER ANY OTHER LEGAL THEORY. Some countries, districts or states do not allow the exclusion or limitation of relief, special, incidental, consequential or indirect damages, or the limitation of liability to specified amounts, so the above limitations or exclusions may not apply to you.

Exclusive Remedy

TO THE MAXIMUM EXTENT PERMITTED BY LAW, THIS LIMITED WARRANTY AND THE REMEDIES SET FORTH ABOVE ARE EXCLUSIVE AND IN LIEU OF ALL OTHER WARRANTIES, REMEDIES AND CONDITIONS, WHETHER ORAL OR WRITTEN, EXPRESS OR IMPLIED. TO THE MAXIMUM EXTENT PERMITTED BY LAW, KRAMER ELECTRONICS SPECIFICALLY DISCLAIMS ANY AND ALL IMPLIED WARRANTIES, INCLUDING, WITHOUT LIMITATION, WARRANTIES OF MERCHANTABILITY AND FITNESS FOR A PARTICULAR PURPOSE. IF KRAMER ELECTRONICS CANNOT LAWFULLY DISCLAIM OR EXCLUDE IMPLIED WARRANTIES UNDER APPLICABLE LAW, THEN ALL IMPLIED WARRANTIES COVERING THIS PRODUCT, INCLUDING WARRANTIES OF MERCHANTABILITY AND FITNESS FOR A PARTICULAR PURPOSE, SHALL APPLY TO THIS PRODUCT AS PROVIDED UNDER APPLICABLE LAW.

IF ANY PRODUCT TO WHICH THIS LIMITED WARRANTY APPLIES IS A "CONSUMER PRODUCT" UNDER THE MAGNUSON-MOSS WARRANTY ACT (15 U.S.C.A. §2301, ET SEQ.) OR OTHER APPLICABLE LAW, THE FOREGOING DISCLAIMER OF IMPLIED WARRANTIES SHALL NOT APPLY TO YOU, AND ALL IMPLIED WARRANTIES ON THIS PRODUCT, INCLUDING WARRANTIES OF MERCHANTABILITY AND FITNESS FOR THE PARTICULAR PURPOSE, SHALL APPLY AS PROVIDED UNDER APPLICABLE LAW.

Other Conditions

This limited warranty gives you specific legal rights, and you may have other rights which vary from country to country or state to state.

This limited warranty is void if (i) the label bearing the serial number of this product has been removed or defaced, (ii) the product is not distributed by Kramer Electronics or (iii) this product is not purchased from an authorized Kramer Electronics reseller. If you are unsure whether a reseller is an authorized Kramer Electronics reseller, please visit our Web site at www.kramerelectronics.com or contact a Kramer Electronics office from the list at the end of this document.

Your rights under this limited warranty are not diminished if you do not complete and return the product registration form or complete and submit the online product registration form. Kramer Electronics thanks you for purchasing a Kramer Electronics product. We hope it will give you years of satisfaction.



For the latest information on our products and a list of Kramer distributors, visit our Web site where updates to this user manual may be found.

We welcome your questions, comments, and feedback.

Web site: www.kramerelectronics.com

E-mail: info@kramerel.com

CE



SAFETY WARNING

Disconnect the unit from the power supply before opening and servicing



P/N: 2900-300189



Rev: 1