



**UC3022**  
**CAMLIVE™ PRO**  
**Dual HDMI to USB-C UVC Video Capture**  
**User Manual**



## EMC Information

### FEDERAL COMMUNICATIONS COMMISSION INTERFERENCE

**STATEMENT:** This equipment has been tested and found to comply with the limits for a Class B digital service, pursuant to Part 15 of the FCC rules. These limits are designed to provide reasonable protection against harmful interference in a residential installation. Any changes or modifications made to this equipment may void the user's authority to operate this equipment. This equipment generates, uses, and can radiate radio frequency energy. If not installed and used in accordance with the instructions, may cause harmful interference to radio communications. However, there is no guarantee that interference will not occur in a particular installation.

This device complies with Part 15 of the FCC Rules. Operation is subject to the following two conditions: (1) this device may not cause harmful interference, and (2) this device must accept any interference received, including interference that may cause undesired operation.

If this equipment does cause harmful interference to radio or television reception, which can be determined by turning the equipment off and on, the user is encouraged to try to correct the interference by one or more of the following measures:

- ◆ Reorient or relocate the receiving antenna.
- ◆ Increase the separation between the equipment and receiver.
- ◆ Connect the equipment into an outlet on a circuit different from that to which the receiver is connected.
- ◆ Consult the dealer or an experienced radio/TV technician for help.

**FCC Caution:** Any changes or modifications not expressly approved by the party responsible for compliance could void the user's authority to operate this equipment.

### KCC Statement

유선 제품용 / B 급 기기 (가정용 방송 통신 기기)  
이 기기는 가정용 (B 급) 전자파적합기기로서 주로 가정에서 사용하는 것을 목적으로 하며, 모든 지역에서 사용할 수 있습니다.



The frequency and maximum EIRP Power in EU are listed as below  
2402MHz~2480MHz:0.32dBm

You are cautioned that changes or modifications not expressly approved by the part responsible for compliance could void the user's authority to operate the equipment.

FCC RF Radiation Exposure Statement:

1. This Transmitter must not be co-located or operating in conjunction with any other antenna or transmitter.
2. This equipment complies with FCC RF radiation exposure limits set forth for an uncontrolled environment. This equipment should be installed and operated with a minimum distance of 20 centimeters between the radiator and your body.

Radiation Exposure Statement: This equipment complies with IC radiation exposure limits established for an uncontrolled environment. This equipment must be installed and operated with a minimum distance of 20 cm between the radiation source and your body.

Declaration d'exposition aux radiations: Cet équipement est conforme aux limites d'exposition aux rayonnements IC établies pour un environnement non contrôlé. Cet équipement doit être installé et utilisé avec un minimum de 20 cm de distance entre la source de rayonnement et votre corps.

This equipment should be installed and operated with a minimum distance of 20 cm between the radiator and your body.

Dieses Gerät sollte mit einem Mindestabstand von 20 cm zwischen dem Kühler und Ihrem Körper installiert und betrieben werden.

## **RoHS**

---

This product is RoHS compliant.

警告使用者：此為甲類資訊技術設備，於居住環境中使用時，可能會造成射頻擾動，在此種情況下，使用者會被要求採取某些適當的對策。

設備名稱 Equipment Name	CAMLIVE™ PRO 雙 HDMI 至 USB-C UVC 視訊影像擷取 器		型號 ( 型式 ) Type designa- tion (Type)	UC3022		
單元 Unit	限用物質及其化學符號 Restricted substances and its chemical symbols					
	鉛 Lead (Pb)	汞 Mercury (Hg)	鎘 Cadmium (Cd)	六價鉻 Hexavalent chromium (Cr <sup>+6</sup> )	多溴聯苯 Polybrominated biphenyls (PBB)	多溴二苯醚 Polybrominated diphenyl ethers (PBDE)
電纜線 Cable	-	○	○	○	○	○
印刷電路部件 PCBA	-	○	○	○	○	○
塑膠 / 其他部件 Plastic / Other parts	○	○	○	○	○	○
金屬部件 Metal parts	-	○	○	○	○	○

備考 1. “超出 0.1 wt %” 及 “超出 0.01 wt %” 係指限用物質之百分比含量超出百分比含量基準值。

Note 1: “Exceeding 0.1 wt %” and “exceeding 0.01 wt %” indicate that the percentage content of the restricted substance exceeds the reference percentage value of presence condition.

備考 2. “○” 係指該項限用物質之百分比含量未超出百分比含量基準值。

Note 2: “○” indicates that the percentage content of the restricted substance does not exceed the percentage of reference value of presence.

備考 3. “-” 係指該項限用物質為排除項目。

Note 3: “-” indicates that the restricted substance corresponds to the exemption.

製造商：宏正自動科技股份有限公司

地址：新北市汐止區大同路二段 125 號三樓

最大操作環境溫度：40°C

最大額定電壓：DC 5V



## User Information

---

### Online Registration

Be sure to register your product at our online support center:

International	<a href="http://eservice.aten.com">http://eservice.aten.com</a>
---------------	---

### Telephone Support

For telephone support, call this number:

International	886-2-8692-6959
China	86-400-810-0-810
Japan	81-3-5615-5811
Korea	82-2-467-6789
North America	1-888-999-ATEN ext 4988 1-949-428-1111

### User Notice

All information, documentation, and specifications contained in this manual are subject to change without prior notification by the manufacturer. The manufacturer makes no representations or warranties, either expressed or implied, with respect to the contents hereof and specifically disclaims any warranties as to merchantability or fitness for any particular purpose. Any of the manufacturer's software described in this manual is sold or licensed as *is*. Should the programs prove defective following their purchase, the buyer (and not the manufacturer, its distributor, or its dealer), assumes the entire cost of all necessary servicing, repair and any incidental or consequential damages resulting from any defect in the software.

The manufacturer of this system is not responsible for any radio and/or TV interference caused by unauthorized modifications to this device. It is the responsibility of the user to correct such interference.

The manufacturer is not responsible for any damage incurred in the operation of this system if the correct operational voltage setting was not selected prior to operation. PLEASE VERIFY THAT THE VOLTAGE SETTING IS CORRECT BEFORE USE.

## Package Contents

---

- 1 UC3022 CAMLIVE™ PRO Dual HDMI to USB-C UVC Video Capture
- 1 USB-B to USB-C Cable
- 1 USB-B to USB-A Cable
- 1 Power Adapter
- 1 Camera Mount Adapter Kit
- 1 User Instructions

\*When using the CAMLIVE™ PRO, if you are only detecting MJPG video, please disconnect the USB-C or USB-A head that you connected with the host. Flip the USB-C or USB-A head around and reconnect it to the host. Please refer to *Using the USB Cables* on page 22 for more details.

---

**Note:** Make sure that all of the components are present and in good order. If anything is missing or was damaged in shipping, contact your dealer.

---

# Table of Contents

---

EMC Information . . . . .	ii
RoHS . . . . .	iii
User Information . . . . .	v
Online Registration . . . . .	v
Telephone Support . . . . .	v
User Notice . . . . .	v
Package Contents . . . . .	vi
About this Manual . . . . .	ix
Conventions . . . . .	x
Product Information . . . . .	x
<b>1. Introduction</b>	
Overview . . . . .	1
Features . . . . .	2
Planning the Installation . . . . .	2
Requirements . . . . .	2
Supported Operation System and Requirements . . . . .	3
Components . . . . .	4
Front View . . . . .	4
Rear View . . . . .	6
<b>2. Hardware Setup</b>	
Mounting the Camera Mount Adapter . . . . .	7
Connecting the CAMLIVE™ PRO Unit . . . . .	8
Aten OnAir Lite App Installation . . . . .	10
Software . . . . .	11
PC . . . . .	11
Android Smartphone . . . . .	11
<b>3. Livestream / Record Setup</b>	
Livestream / Record Platform . . . . .	13
Discovering CAMLIVE on your System . . . . .	13
Mac Operation System . . . . .	13
Windows Operation System . . . . .	16
Video and Audio Setup . . . . .	18
Using the USB Cables . . . . .	22
HDCP Switching . . . . .	23
Resetting the CAMLIVE™ PRO . . . . .	24
<b>4. Aten OnAir Lite App</b>	
ATEN OnAir Lite Application . . . . .	25
Supported Systems . . . . .	25
Installing the CAMLIVE™ PRO . . . . .	25

Connecting the CAMLIVE™ PRO on your Mobile Device . . . . .	26
Disconnecting the CAMLIVE™ PRO from your Mobile Device . . . . .	27
Page Components . . . . .	28
Information Tab . . . . .	28
Video Mixer . . . . .	29
Scene Editor . . . . .	31
Overlay Button . . . . .	32
Switching Video Source . . . . .	32
Reset Button . . . . .	33
Resize/Crop Tool . . . . .	33
Resize . . . . .	33
Crop . . . . .	34
Audio Mixer . . . . .	36
Settings Panel . . . . .	39
Chroma Key . . . . .	39
Selecting Color . . . . .	40
Auto Switch . . . . .	41
More Settings . . . . .	42
Advanced . . . . .	42
Resetting the CAMLIVE™ PRO . . . . .	43
ATEN OnAir Lite App Factory Default Settings . . . . .	44

## 5. The Firmware Upgrade Utility

Overview . . . . .	47
Downloading the Firmware Upgrade Package . . . . .	47
Preparation . . . . .	48
Starting the Upgrade . . . . .	49
Upgrade Succeeded . . . . .	51
Upgrade Failed . . . . .	52

## Appendix

Safety Instructions . . . . .	53
General . . . . .	53
Technical Support . . . . .	55
International . . . . .	55
North America . . . . .	55
Specifications . . . . .	56
Limited Warranty . . . . .	58



## About this Manual

---

This user manual is provided to help you get the most from the CAMLIVE™ PRO unit. It covers all aspects of installation, configuration, and operation. An overview of the information found in the manual is provided below.

**Chapter 1, Introduction** introduces you to the Dual HDMI to USB-C UVC Video Capture. Its purpose, features, installation considerations, and panel components are presented and described.

**Chapter 2, Hardware Setup** describes the steps that are necessary to quickly and safely set up your installation.

**Chapter 3, Livestream / Record Setup** explains how to find CAMLIVE on your system and presents how to setup video and audio source using an example live-stream/record software/platform.

**Chapter 4, Aten OnAir Lite App** explains how to download and configure the CAMLIVE™ PRO's OnAir Lite App.

**Chapter 5, The Firmware Upgrade Utility** explains how to download the CAMLIVE™ PRO's firmware and upgrade the device using the utility.

**An Appendix** provides a list of safety instructions and precautions, contact information for ATEN technical support, product specifications, and other technical information.

---

### Note:

- ◆ Read this manual thoroughly and follow the installation and operation procedures carefully to prevent any damage to the unit or any connected devices.
  - ◆ ATEN regularly updates its product documentation for new features and fixes. For an up-to-date CAMLIVE™ PRO documentation, visit <http://www.aten.com/global/en/>
-

## Conventions

---

This manual uses the following conventions:

- `Monospaced`      Indicates text that you should key in.
- [ ]                      Indicates keys you should press. For example, [Enter] means to press the **Enter** key. If keys need to be chorded, they appear together in the same bracket with a plus sign between them: [Ctrl+Alt].
- 1.                        Numbered lists represent procedures with sequential steps.
- ◆                        Bullet lists provide information, but do not involve sequential steps.
- Indicates selecting the option (on a menu or dialog box, for example), that comes next. For example, Start → Run means to open the *Start* menu, and then select *Run*.
-                       Indicates critical information.

## Product Information

---

For information about all ATEN products and how they can help you connect without limits, visit ATEN on the Web or contact an ATEN Authorized Reseller. Visit ATEN on the Web for a list of locations and telephone numbers:

International	<a href="http://www.aten.com">http://www.aten.com</a>
North America	<a href="http://www.aten-usa.com">http://www.aten-usa.com</a>

# Chapter 1

## Introduction

### Overview

---

The CAMLIVE™ PRO is designed to easily capture and mix the two connected 4K video sources in FHD format for livestream purpose with outstanding video effects and remarkable image quality. This video capture device combines video capture, encoding, and 2-channel video mixing and switching from HDMI source and professional line-level audio device. It helps livestreaming become unique and stand out from thousands of CDN videos. The CAMLIVE™ PRO supports easy switch between multiple connected sources and combine them for a rich information delivery in steaming. In addition, it automatically converts the sources to clean-looking USB video format in 720P or 1080P, which is sent to your laptop/smartphone via USB.

Easy to use – the CAMLIVE™ PRO provides an intuitive ATEN OnAir Lite App. This App places everything you need to customize your video stream right at your fingertips. Combine, crop, and scale video to make outstanding PnP layouts. Preset up to 8 custom scenes and manage audio sources with the intuitive touch panel interface for a superior pro-level finish. Open up a world of possibilities by using the chroma keying. You can make it look like you are anywhere by changing the background for eye-popping effects.

Providing smooth video streaming workflow for dual camera or single operator setups, the CAMLIVE™ PRO allows any streamer to broadcast over internet for higher quality livestream to major streaming services or remote conferencing service such as YouTube Live, Facebook, OBS, Microsoft Teams, Microsoft Mixer, Zoom, CameraFi, and Twitch. It enables eye-popping, high-quality one stop programming streaming broadcasting capability with PC and Mac platform.

Whether you're capturing, editing or streaming, the CAMLIVE™ PRO is flexible enough to fit all independent livestreaming broadcasting environments. This micro device packs several features in one such as and its lightweight design makes it possible to fit in any case and bring it to any live event. With just the CAMLIVE™ PRO, companion app, and your laptop / smartphone, you have all the devices you need to present engaging livestreaming that will rival the most advanced streamers on social media and provides an easy-to-use solution.

## Features

---

- ◆ Mix and capture two unencrypted 4K live videos at 1080P UVC format on PC or mobile device via USB 3.x interface with seamless transition
- ◆ Intuitive Android/iOS App control – set up your camera gear and direct your show from anywhere
- ◆ Supports real-time HDMI program video preview
- ◆ Easily identifiable chroma keys – can make the video look like you are anywhere by changing the background
- ◆ Provides audio mixer with additional dual analog audio inputs
- ◆ Supports protected video (encrypted) switching mode for regular event usage
- ◆ Compatible with USB & Thunderbolt 3 (USB-C)

## Planning the Installation

---

### Requirements

Prepare the following before installing the CAMLIVE™ PRO unit:

- ◆ 2 HDMI source devices
- ◆ 1 HDMI display
- ◆ 1 XLR audio source
- ◆ 1 RCA audio source
- ◆ 1 Mobile Device (Android / iOS)

---

## Supported Operation System and Requirements

---

Operation System	Minimum Hardware Requirement
Windows 7 with <i>Win7_driver</i> installed	CPU: Intel® i3 Dual Core 2.8Ghz or higher
Windows 10 or later	RAM: 4GB or more
OS X 10.13 or later	One USB-C Interface or USB-A Interface
Android 5.0.1 or later with UVC support	Android smartphone with UVC and USB-C Interface

---

**Note:** For Windows 7 users, please download and install the *Win7\_driver* from on our website. To download the driver, see *Downloading the Firmware Upgrade Package*, page 47.

---

# Components

## Front View

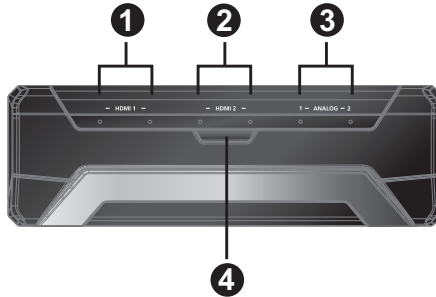

No.	Component	Description
1	HDMI 1 Video Status LED	The LED lights green to indicate the HDMI 1 video source connection is in effect.
	HDMI 1 Audio Status LED	The LED lights green to indicate the HDMI 1 audio source connection is in effect. The LED lights orange to indicate the HDMI 1 audio source connection is muted.
2	HDMI 2 Video Status LED	The LED lights green to indicate the HDMI 2 video source connection is in effect.
	HDMI 2 Audio Status LED	The LED lights green to indicate the HDMI 2 audio source connection is in effect. The LED lights orange to indicate the HDMI 2 audio source connection is muted.
3	Analog 1 Audio Status LEDs	The LED lights green to indicate the Analog 1 (RCA) audio source connection is in effect. The LED lights orange to indicate the Analog 1 (RCA) audio source connection is muted.
	Analog 2 Audio Status LEDs	The LED lights green to indicate the Analog 2 (XLR) audio source connection is in effect. The LED lights orange to indicate the Analog 2 (XLR) audio source connection is muted.

---

No.	Component	Description
4	Bluetooth Link Pushbutton	<p>Press to quickly switch between scene 1 and scene 2.</p> <p>Press and hold 3 seconds to disconnect the bluetooth connection between CAMLIVE™ PRO and your mobile device.</p> <p>Press and hold the Bluetooth Link Pushbutton, and power on the CAMLIVE™ PRO to perform a firmware upgrade. See <i>Preparation</i>, page 48.</p> <p>Press and hold the Bluetooth Link Pushbutton, power on the CAMLIVE™ PRO, and wait for 10 seconds to reset the unit. See <i>Resetting the CAMLIVE™ PRO</i>, page 24.</p>

---

**Note:**

- ◆ All the LEDs blink at the same time to indicate that the firmware upgrade is in progress.
  - ◆ The HDMI 1 Video Status LED and the HDMI 2 Video Status LED blink once every 0.5 seconds for 3 seconds when you disconnect the bluetooth connection.
-

## Rear View

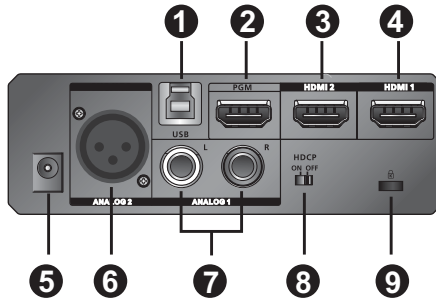

No.	Component	Description
1	USB-B UVC Output Port	Connects to a host.
2	HDMI Program Output Port	Programmed (PGM) Video Output.
3	HDMI 2 Input Port	Connects to an HDMI input.
4	HDMI 1 Input Port	Connects to an HDMI input.
5	Power Jack	The power adapter plugs here.
6	Analog 2 Input Port	Connects XLR audio source here.
7	Analog 1 Input Port (L/R)	Connects RCA audio source here.
8	HDCP Switch	Switch to display HDCP protected content.
9	Kensington Lock	Kensington security slot plugs here.



## Chapter 2 Hardware Setup



Please review the safety information regarding the placement of this device in *Safety Instructions*, page 53.

### Mounting the Camera Mount Adapter

---

To mount the camera mount adapter, screw the camera mount adapter on the bottom of the CAMLIVE™ PRO with the screws provided in the Camera Mount Adapter Kit.

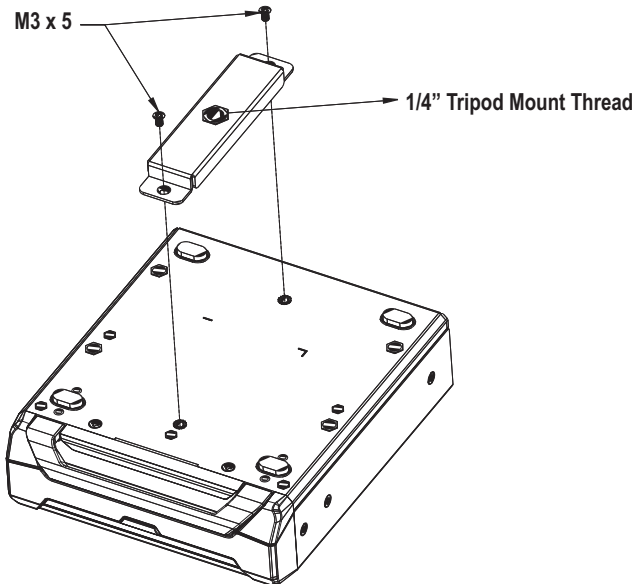

## Connecting the CAMLIVE™ PRO Unit

Follow the steps below to connect the CAMLIVE™ PRO.

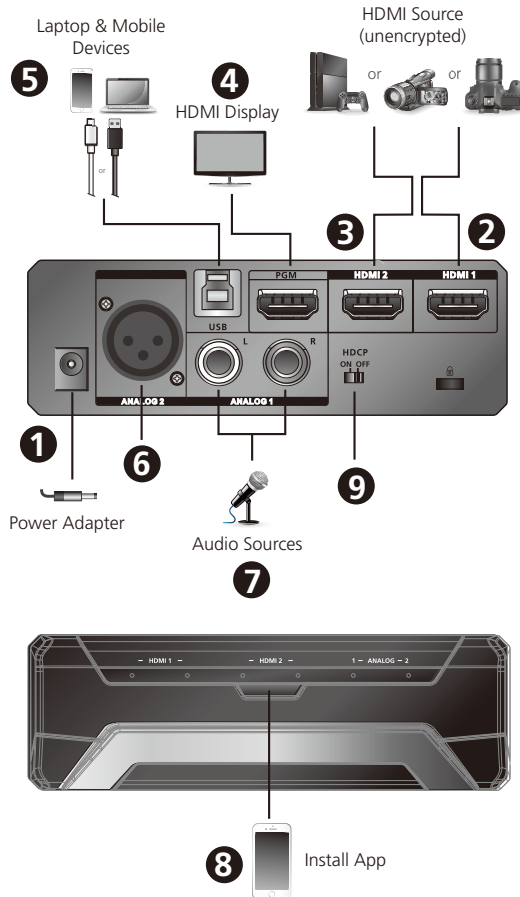

1. Plug the power adapter cable into the Power Jack.
2. Connect your first HDMI source device to the HDMI 1 Input Port.\*
3. Connect your second HDMI source device to the HDMI 2 Input Port.\*
4. Connect the HDMI Program Output Port to an HDMI-enabled display using an HDMI cable (not included) to display your pre-programmed HDMI content.
5. If your laptop only has a USB-A interface, connect the USB-B to USB-A Cable (included) to your laptop. Or, if your Android mobile device / laptop

only has a USB-C interface, connect the USB-B to USB-C Cable (included) to your Android mobile device / laptop respectively.

6. Connect your XLR audio source to the Analog 2 Input Port.
7. Connect your RCA audio source to the Analog 1 Input Port.
8. Open the ATEN OnAir Lite App to pair up the CAMLIVE™ PRO with your app installed mobile device. For more information, see *Aten OnAir Lite App*, page 25.

---

**Note:** Please make sure to enable the GPS function before you begin to use the ATEN OnAir Lite App.

---

## Android

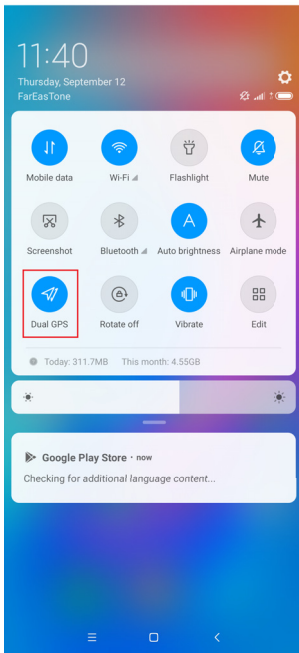

## iOS

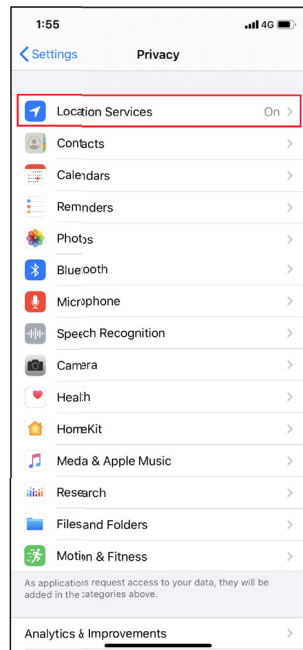

9. (Optional) For video switching, to display the HDCP protected content to the connected HDMI display (without video capture), please put the HDCP Switch to ON.

---

**Note:** \* The CAMLIVE™ PRO cannot capture HDCP protected content.

---

## **Aten OnAir Lite App Installation**

---

Download and install the ATEN OnAir Lite App from the Play Store to your Android mobile device. This App is designed for the UC3022 to manage and edit the program results. The ATEN OnAir Lite App includes the following power features.

- ◆ Storyboard-like management
- ◆ Scenes editor
- ◆ Audio sensing switch
- ◆ Chroma keyin management
- ◆ Audio mixer management

## Software

---

To enable CAMLIVE™ PRO, please download and install a suitable video recording or live streaming software for your requirement.

### **PC**

Below lists some examples of supported video recording / live streaming software for PC.

All trademarks are property of their respective owners.

[OBS: https://obsproject.com](https://obsproject.com)

[Xsplit: https://www.xsplit.com](https://www.xsplit.com)

<https://www.youtube.com>

<https://www.facebook.com>

<https://www.zoom.com>

<https://www.skype.com>

<https://www.microsoft.com/en-us/microsoft-365>

### **Android Smartphone**

Below is an example of supported video recording / live streaming for Android smartphone.

All trademarks are property of their respective owners.

<http://www.camerafi.com/supported-devices/>

A general reference of how to go about using CAMLIVE™ PRO is described in the next chapter.

This Page Intentionally Left Blank

# Chapter 3

## Livestream / Record Setup

### Livestream / Record Platform

Below lists a few of the available live-streaming or recording software/platforms:

OBS: <https://obsproject.com>

Xsplit: <https://www.xsplit.com>

<https://www.youtube.com>

<https://www.facebook.com>

<https://www.zoom.com>

<https://www.skype.com>

<https://www.microsoft.com/en-us/microsoft-365>

All trademarks are property of their respective owners.

### Discovering CAMLIVE on your System

CAMLIVE™ PRO is a plug-and-play device, please make sure your system is able to discover it. After connecting CAMLIVE™ PRO as shown in *Connecting the CAMLIVE™ PRO Unit* on page 8, refer to the examples below on how your system may discover CAMLIVE™ PRO.

### Mac Operation System

1. On the desktop, click to select “Go” followed by “Utilities”.

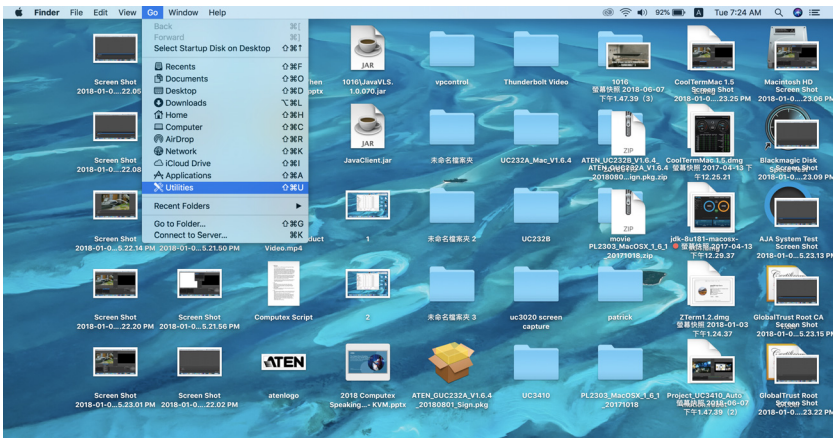

2. On the “Utilities” window, double-click “System Information” to bring up the system window.



3. Go to the USB page by clicking “USB” under “Hardware”.

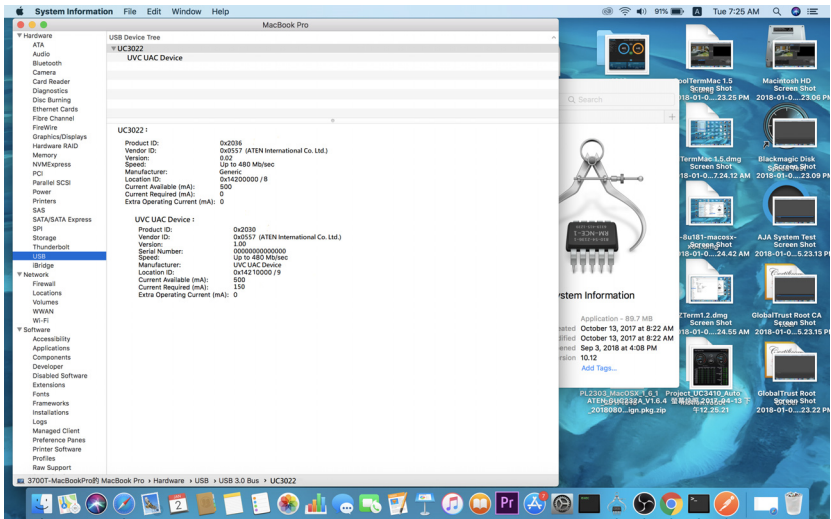



- Under “USB 3.0 Bus”, you should see an “HDMI to U3 capture”. This indicates that your system has successfully discovered CAMLIVE™ PRO.

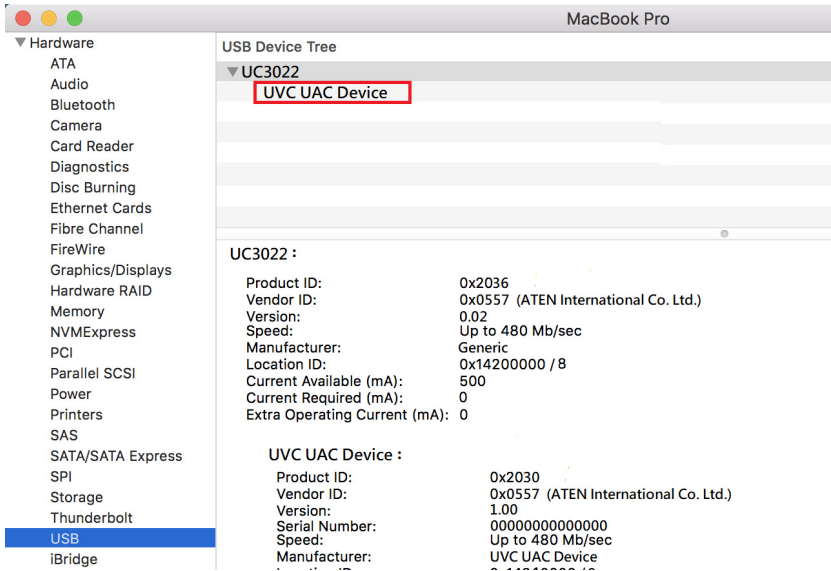

Go to the next section for an example of how to setup both video and audio for live-streaming and recording using CAMLIVE™ PRO.

## Windows Operation System

This is an example used in a Windows 10 Operation System.

1. On a Windows 10 desktop, go to **Control Panel** and select **System**.

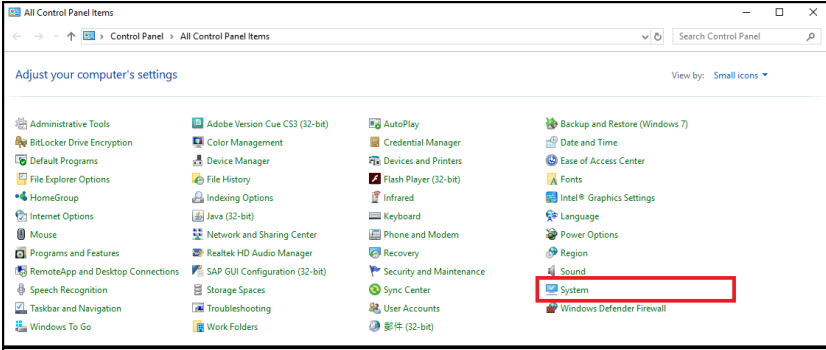

2. The System window appears, select **Device Manager**.

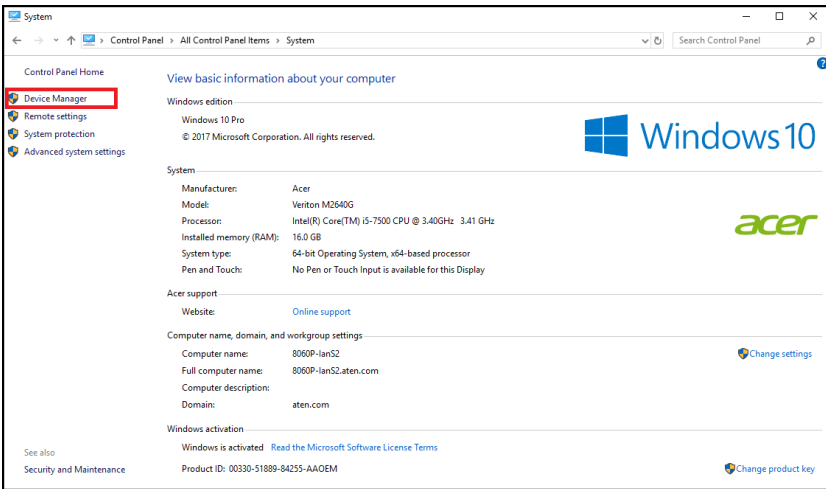

3. The Device Manager window appears. Click on **Cameras** and **Sound, video and game controllers**.

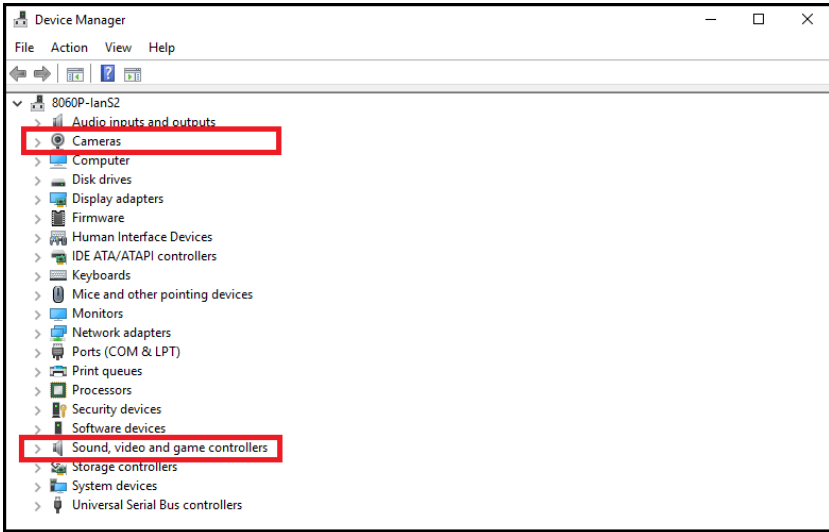

4. You should see an “USB Video Device” in the *Camera list*, and an “USB Audio Device” in the *Sound, video and game controllers list*. This indicates that your system has successfully discovered CAMLIVE™ PRO.

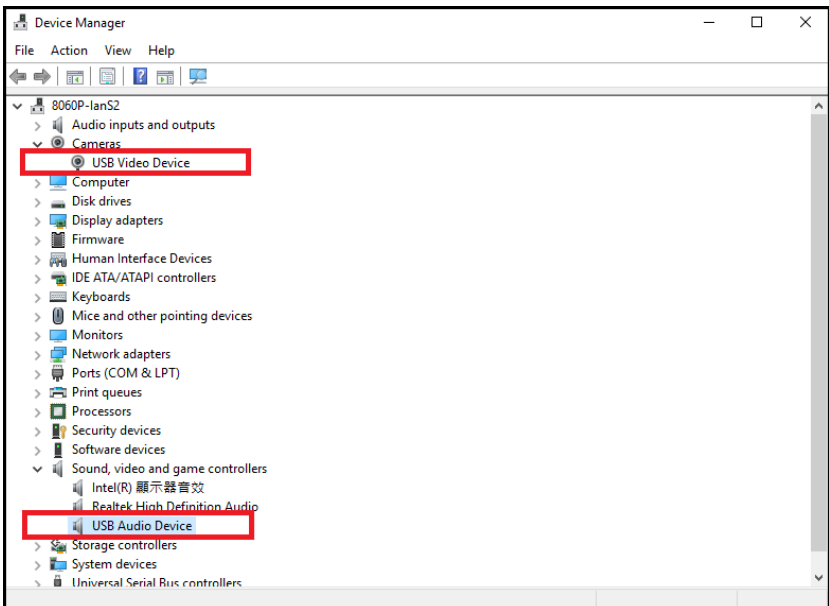

## Video and Audio Setup

After your system discovers CAMLIVE™ PRO, choose your livestream/record platform. You will need to setup the video and audio source coming from CAMLIVE™ PRO.

Follow the steps below to setup your video and audio sources (separately).

**Note:** OBS software is the example used in the setup steps below.

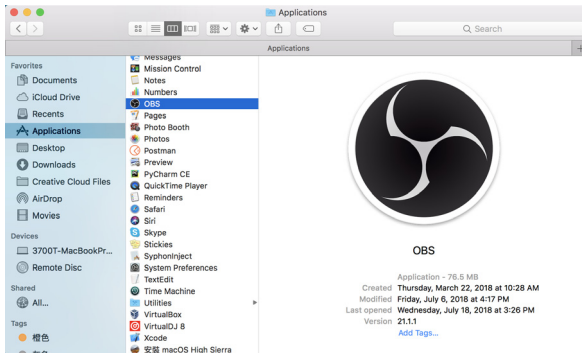

1. On your system, open the OBS software.

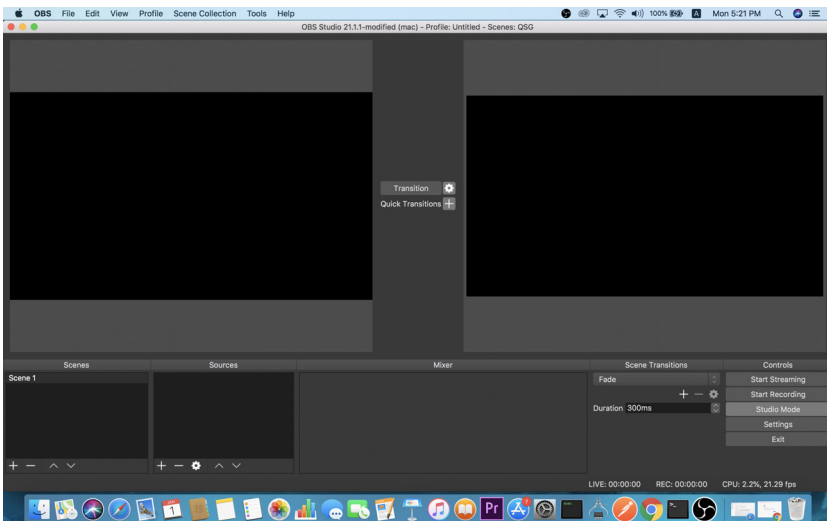

2. Locate and click the “+” button on the bottom of the “Sources” pane (outlined in red in the picture below) to open the add source menu:

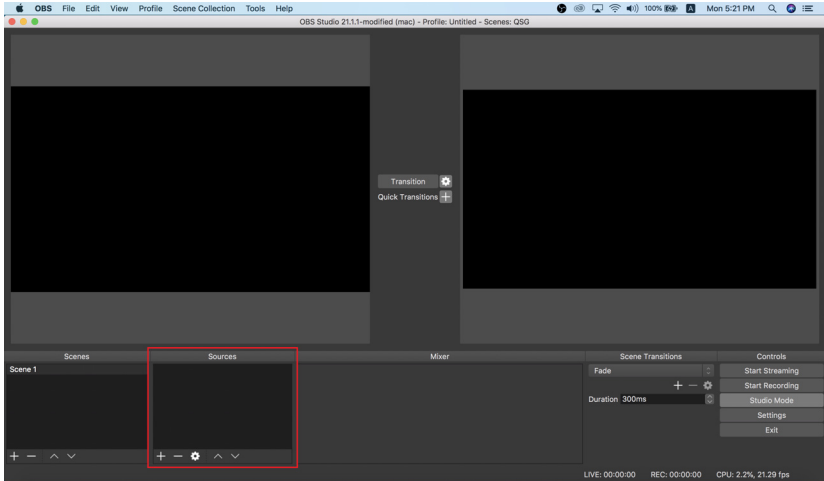

3. Select “Video Capture Device” or “Audio Capture Device.”

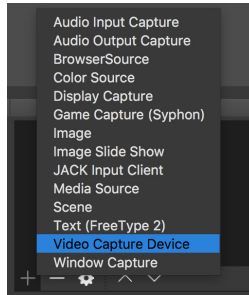

4. A pop-up window will be shown for you to name the video/audio source. Click the “OK” button to continue.

It is recommended that “Make source visible” is checked.

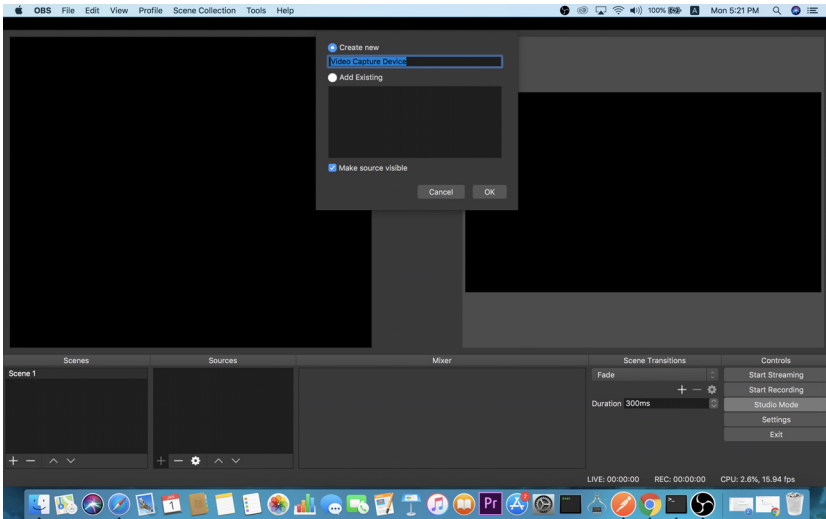

5. On the properties page, click the drop-down menu named “Device” to select CAMLIVE™ PRO’s video/audio source. Both the video and audio sources of CAMLIVE™ PRO have the name “HDMI to U3 capture”.

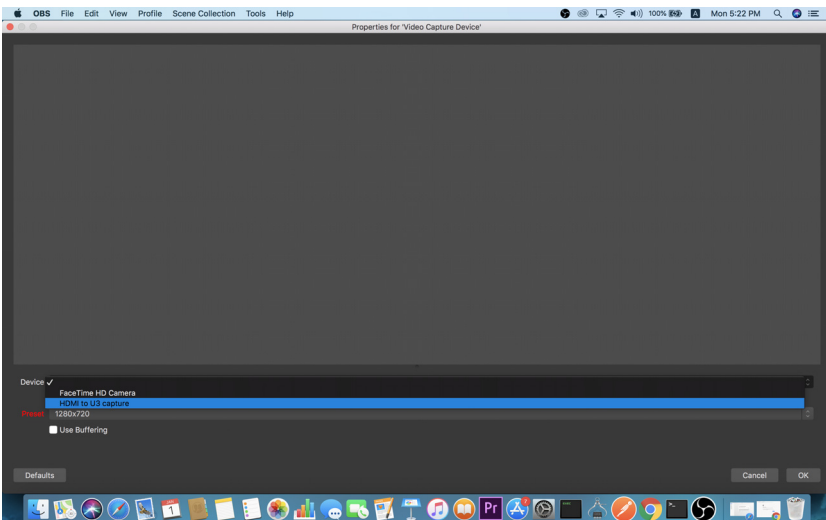

After selecting the video source, the image from CAMLIVE™ PRO should be displayed as shown below.

Click the “OK” button to continue.



6. For successful setup, the sources will be shown in the “Source” pane.

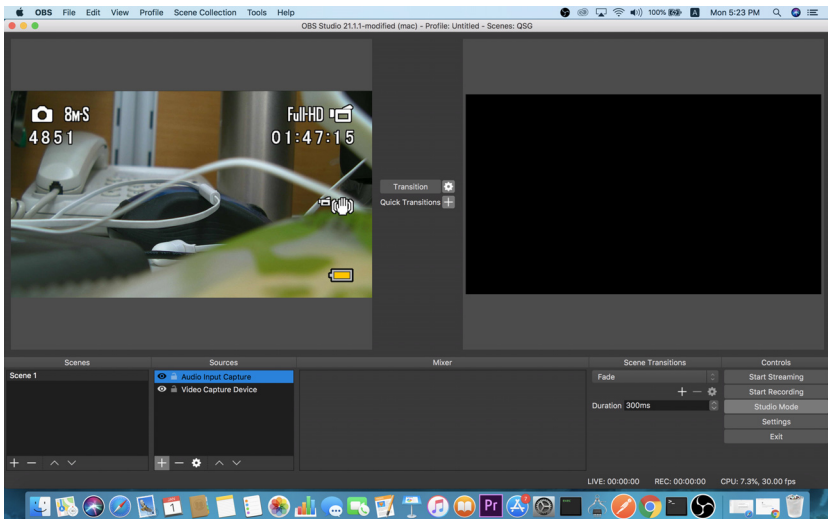

Setup of video and audio sources are complete, you can now start live-streaming/video recording.

Detailed configuration of your live-streaming/video recording software/platform is not within the scope of this user manual, please refer to the software/platform’s instruction guides/manual.

## Using the USB Cables

When connecting CAMLIVE™ PRO on a PC with a USB2.0 interface, it will automatically set the provided compressed video quality to the MJPEG compression mode to fit the data bandwidth. For better video quality, we strongly recommend to connect CAMLIVE™ PRO to a USB3.1 Gen1 interface.

To make sure the result match your media output you wish to capture, please check the detected video format from your capture software first.

Capture device custom setting page examples displaying USB 3.1-RAW and USB2.0-MJPEG on OBS software are shown below:

- ◆ USB2.0 mode with MJPEG video format only

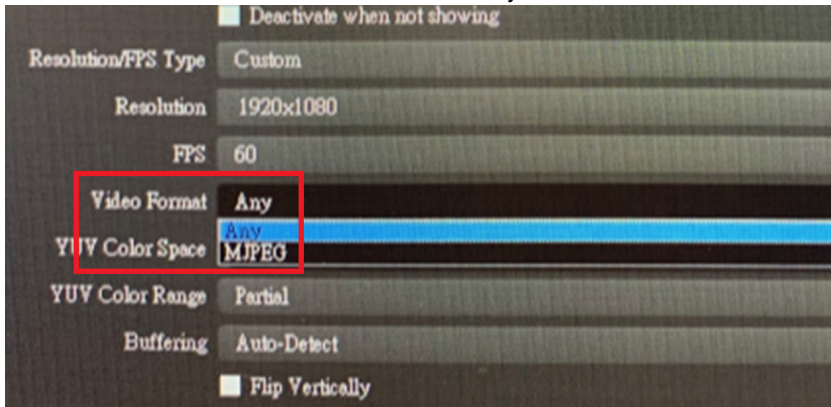

- ◆ USB3.1 mode with RAW (YUY2) and MJPEG video formats

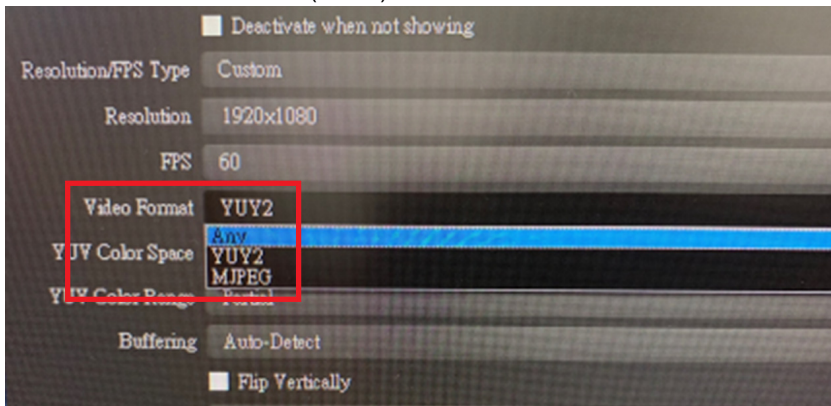



If you find that the captured media only has MJPEG format, simply flip the USB-B to USB-C Cable connector connected to the CAMLIVE™ PRO as shown in the diagram below:

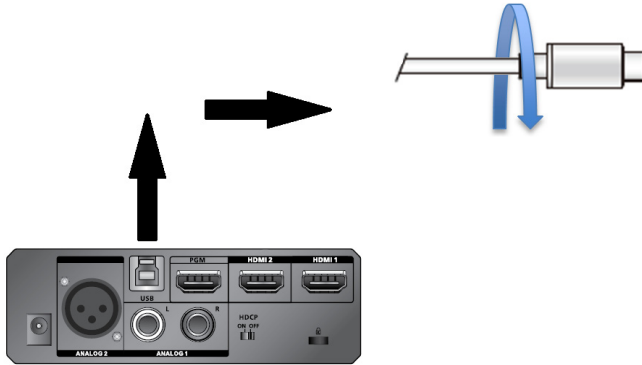

## HDCP Switching

To display HDCP protected content via the HDMI Program Output Port using an HDMI cable, switch the HDCP Switch to ON. The default is OFF.

- Note:**
1. The CAMLIVE™ PRO cannot capture HDCP protected content.
  2. UVC / UAC become unavailable when the HDCP Switch is switched to ON.

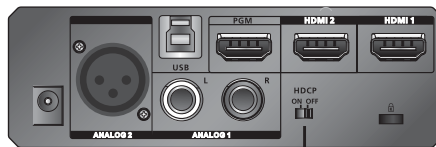

**HDCP Switch**

HDCP	PGM HDMI Output Resolution	Bandwidth Limit	UVC Format under OBS
OFF	720p, 1080p	Off (PC)	720p, 1080p MJPEG or YUY2
		On (Mobile Device)	720p, 1080p MJPEG
ON	720p, 1080p, 2160p @ 30Hz	N/A	N/A

## Resetting the CAMLIVE™ PRO

---

To reset the CAMLIVE™ PRO to its default settings, do the following:

1. Press and hold the Bluetooth Link Pushbutton.



**Bluetooth Link Pushbutton**

2. Plug the power adapter cable into the power jack to power on the CAMLIVE™ PRO. Wait for 10 seconds before you release the Bluetooth Link Pushbutton.
3. The front panel LEDs blink together once every 0.1 seconds and the CAMLIVE™ PRO resets itself back to default settings.

# Chapter 4

## Aten OnAir Lite App

### ATEN OnAir Lite Application

ATEN OnAir Lite App acts as the central controller for CAMLIVE™ PRO. The app's design is a control panel where you can monitor program results, edit scenes, setup video and audio settings, etc. Download the ATEN OnAir Lite app from the App Store or Google Play and install it on your mobile device.

**Note:** 1. The maximum operation hour for the ATEN OnAir Lite App is 4 hours.  
2. Please make sure to enable the GPS function before you begin to use the ATEN OnAir Lite App.



### Supported Systems

The ATEN OnAir Lite App supports the following mobile operating systems:

Mobile Operating System	Supported Versions
Android	version 5 or later
iOS	version 10 or later

### Installing the CAMLIVE™ PRO

1. Install the CAMLIVE™ PRO App on a mobile device.

- From the mobile device, tap the **App Store**  or **Google Play**  icon.
- In the search box, type "CAMLIVE™ PRO".
- Tap CAMLIVE™ PRO and install the app.

2. From the mobile device, tap the **CAMLIVE™ PRO** icon .

3. Follow the on-screen instructions.

## **Connecting the CAMLIVE™ PRO on your Mobile Device**

CAMLIVE™ PRO is a plug-and-play device, after connecting CAMLIVE™ PRO as shown in *Connecting the CAMLIVE™ PRO Unit* on page 8. Open the On Air Lite App, it automatically searches for the CAMLIVE™ PRO, and press **Connect**.

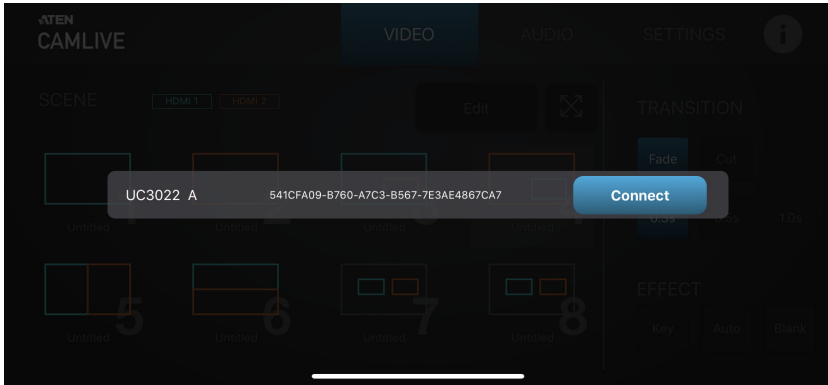

When you have connected to the CAMLIVE™ PRO successfully, the screen below appears.

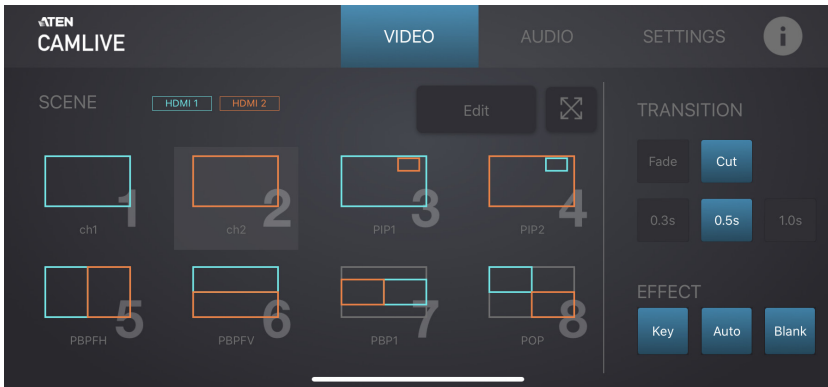

When your mobile device is out of range, a warning message below appears. To connect back to the CAMLIVE™ PRO, press **Connect** and follow the on-screen instructions as explained in *page 26*.

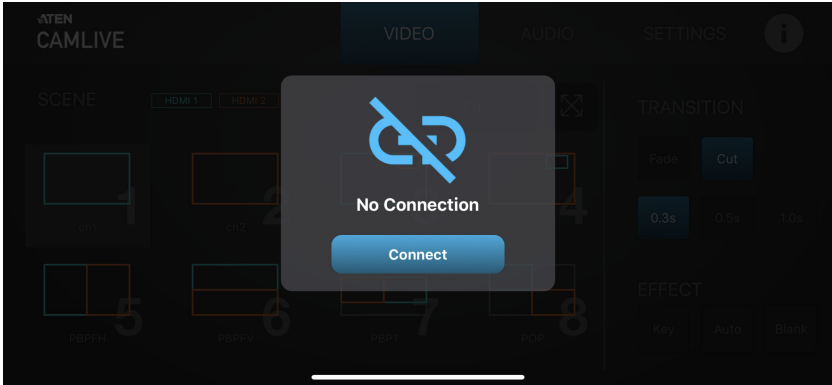

### **Disconnecting the CAMLIVE™ PRO from your Mobile Device**

To connect another mobile device to the CAMLIVE™ PRO, press the Bluetooth Link Pushbutton for 3 seconds. HDMI1 and HDMI 2 LEDs blink together once every 0.5 seconds for 3 seconds.

## Page Components

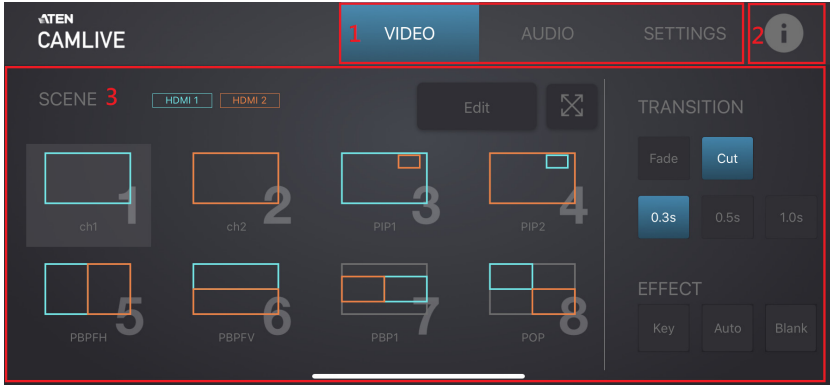

No.	Component	Description
1	Deck Selector	Tap to select the desired configuration deck. Three decks are available: Video Mixer, Audio Mixer, and Settings.
2	Information	Tap to see the current software version, and firmware version information. See <i>Information Tab</i> , page 28.
3	Deck Content	The content depends on the selected deck.

### Information Tab

To browse the current software and firmware version, tap  from the ATEN OnAir Lite App screen.

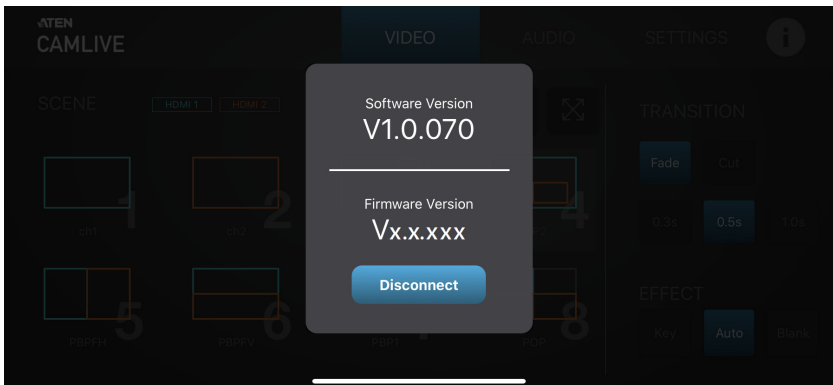



## Video Mixer

The Video Mixer deck page allows you to adjust effect on your video, scene selection and editing, and transition control.

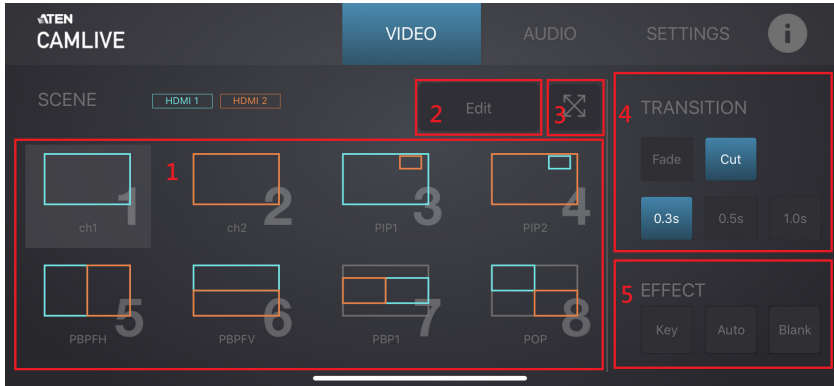
The components of the page is shown below:



No.	Component	Description
1	Scene Selector	<p>8 scenes are shown here.</p> <p>Blue outline scene = HDMI 1. e.g. </p> <p>Orange outline scene = HDMI 2. e.g. </p> <p>Tap a scene to put the scene into the PRV Preview section. To put the scene in PRV Preview to PGM Preview, use the Transition Control (explained below).</p>
2	Scene Editor	<p>You can configure each individual scenes by tapping this icon. Refer to on page 30 on how to edit each scene.</p>

No.	Component	Description
3	Enlarge	
4	Transition Control	<p>Controls the switching for the current stream (PGM).</p> <p>To switch,</p> <ol style="list-style-type: none"> <li>1. Tap the <b>Cut</b> button; or</li> <li>2. Select a specified time between 0.3s, 0.5s, and 1.0s transition, and tap the <b>Fade</b> button.</li> </ol> <p><u>Using the Cut button</u> The transition happens immediately when you tap the <b>Cut</b> button.</p> <p><u>Using the Fade button</u> Tapping the <b>Fade</b> button will begin the transition after a specified time (0.3, 0.5, and 1 seconds).</p>
5	Effect Control	<p>Tap <b>Key</b> to enable the chroma key effect to the HDMI display connected on the HDMI Program Output Port. See <i>Chroma Key</i>, page 39 for more details.</p> <p>Tap <b>Auto</b> to switch display content for the HDMI display connected on the HDMI Program Output Port to follow the input audio source. See <i>Auto Switch</i>, page 41.</p> <p>Tap <b>Blank</b> to bring a blank background to the HDMI display connected on the HDMI Program Output Port.</p>



## Scene Editor

To edit a scene, follow the steps below.

1. Select a scene from the scene selector.
2. Tap the **Edit** button from the Video Mixer page.

An example of a PIP2 is used and shown below:

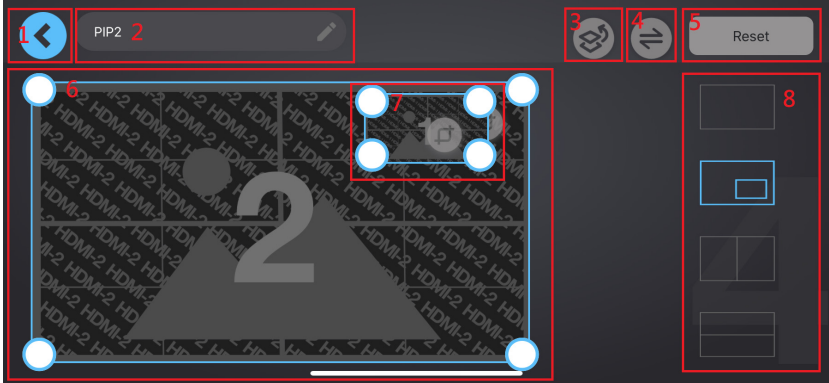

No.	Component	Description
1	Return Button	Tap to return to the Video Mixer page
2	Scene Name	This region displays the scene name. Tap to edit the scene name.
3	Overlay Button	Tap to switch between main display and overlay display. You can also resize and crop the overlay scene.
4	Switch Video Source (Dual-View)	During dual-view, tap this button to switch video source position between HDMI 1 and HDMI 2. You can also resize and crop the switched source.
5	Reset Button	Tap to reset the current scene.
6	HDMI 2 Display and Resize Tool	Displays the HDMI 2 content with resize / crop tool. <ul style="list-style-type: none"> <li>◆ To resize the HDMI 2 content, see <i>Resize</i>, page 33.</li> <li>◆ To crop the HDMI 2 content, see <i>Crop</i>, page 34.</li> </ul>
7	HDMI 1 Display and Resize Tool	Displays the HDMI 1 content with resize / crop tool. <ul style="list-style-type: none"> <li>◆ To resize the HDMI 1 content, see <i>Resize</i>, page 33.</li> <li>◆ To crop the HDMI 1 content, see <i>Crop</i>, page 34.</li> </ul>

No.	Component	Description
8	Layout Selection	Tap to select a preferred layout. You can also resize the dual-view.

### Overlay Button

To view the overlay display from a dual-view scene, tap  from the Scene Editor page.



### Switching Video Source

To switch the video source position between HDMI 1 and HDMI 2, tap  from the Scene Editor page.

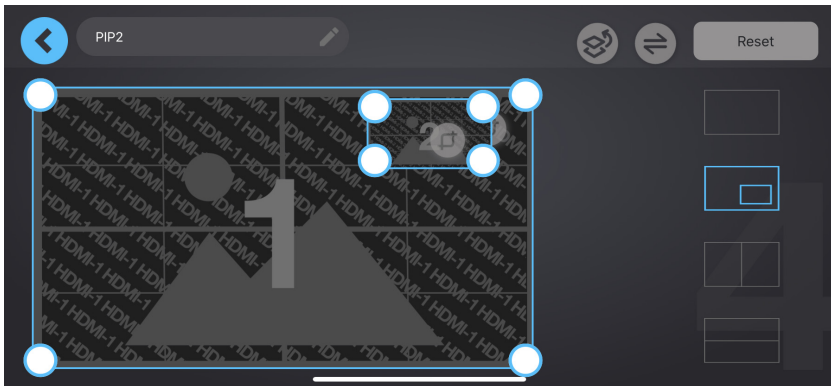

## Reset Button

To reset or undo any changes made to the selected scene, tap **Reset** from the Scene Editor page. A warning message appears, click **OK**.

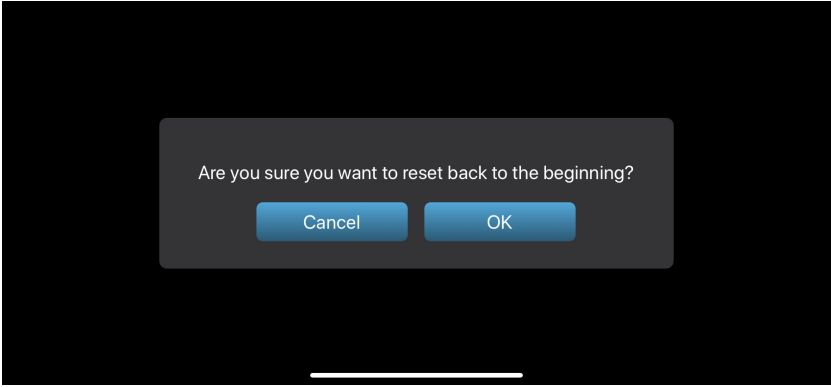



## Resize/Crop Tool

This section describes how to resize or crop HDMI 1 and HDMI 2 of the scene layout.

### Resize

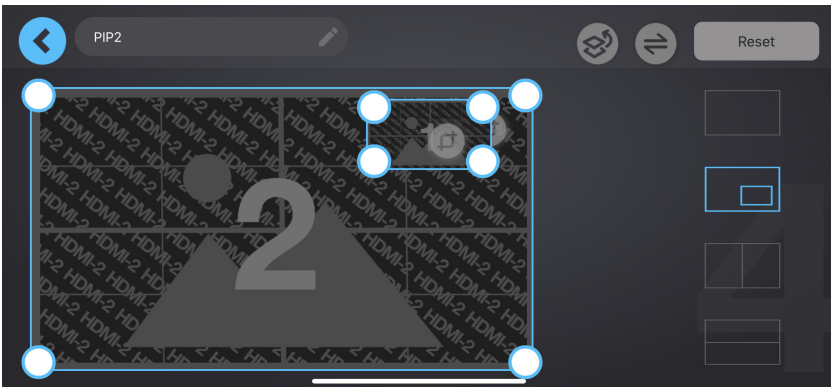
To resize HDMI 1 and HDMI 2 display content, select a scene and tap **Edit** button from the Video Mixer page. A resize tool  will be visible on the HDMI 1 and HDMI 2 displays in the scene editor page. An example of a PIP2 is used and shown below:



Tap and hold to drag the resize tool  to resize the displays.

## Crop

To crop HDMI 1 and HDMI 2 display content, select a scene and tap **Edit** button from the Video Mixer page. A crop tool  will be visible on the HDMI 1 and HDMI 2 displays in the scene editor page. An example of a PIP2 is used and shown below:



To crop the display content, follow the steps below.

1. Tap the crop tool  button and the screen below appears.

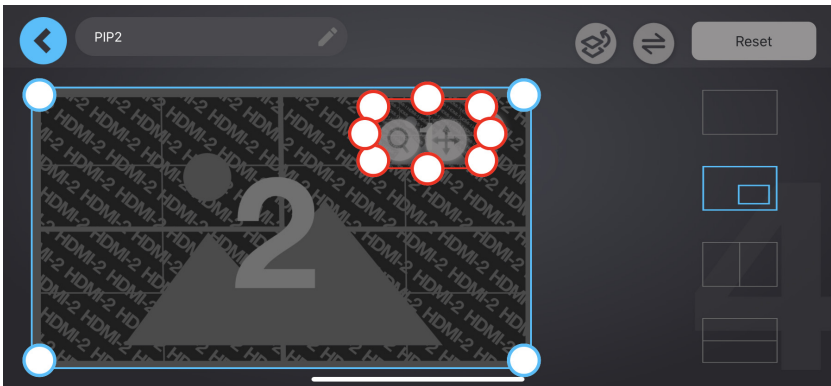

2. Tap the enlarge  button to crop the display content. The screen below appears.



3. Tap and hold to drag the cropping tool point  to adjust the cropping area. Tap and hold to relocate the cropping area.



4. When completed, tap **Done**.

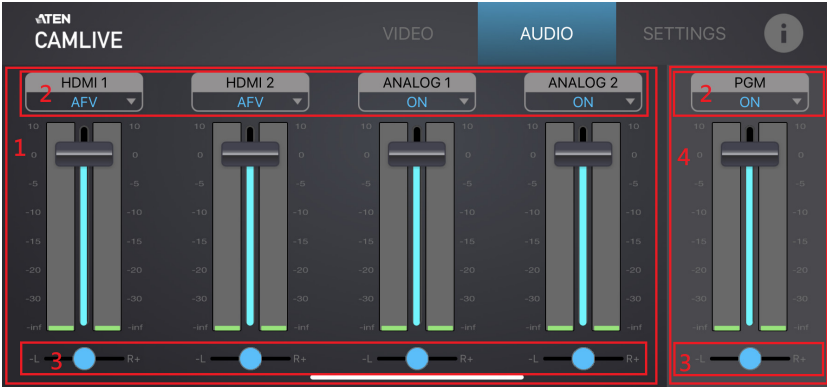

## Audio Mixer

The components of the Audio Mixer deck page is shown below:

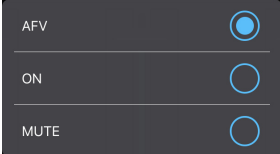
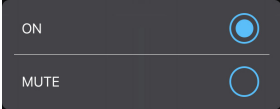
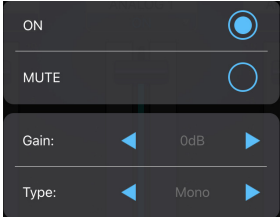

No.	Component	Description
1	Audio Level Control	Slide the volume slider to control the volume of each audio source.

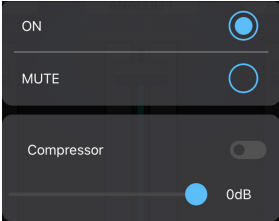
No.	Component	Description
2	Audio Control	<p>Tap to select and adjust audio control. For the LEDs status indication, see <i>Front View</i>, page 4.</p> <p><b>HDMI1 and HDMI2:</b> Tap to select an audio control for HDMI 1 and HDMI 2 between AFV, ON, and MUTE.</p>  <p>AFV (Audio-Follow-Video): Broadcasting the source's video and audio at the same time. ON: The audio is turned on (unmuted). MUTE: The audio is turned off (muted).</p> <p><b>ANALOG 1:</b> Tap to select an audio control for ANALOG 1 between ON, and MUTE.</p>  <p>ON: The audio is turned on (unmuted). MUTE: The audio is turned off (muted).</p> <p><b>ANALOG 2:</b> Tap to select an audio control and adjust MIC Gain settings for ANALOG 2 between ON, and MUTE.</p>  <p>ON: The audio is turned on (unmuted). MUTE: The audio is turned off (muted). Gain: Select the threshold between 0dB, +6dB, +12dB, +18dB, +24dB, and +30dB. Type: Select between Mono and Stereo.</p>

No.	Component	Description
		<p><b>PGM:</b> Tap to select an audio control and adjust compressor settings for PGM between ON, and MUTE.</p>  <p>ON: The audio is turned on (unmuted). MUTE: The audio is turned off (muted). Compressor: Tap to enable or disable the compressor function and drag the dial to adjust the threshold. The default setting is disable.</p> <p>The Compressor looks like this  when it is disabled.</p> <p>The Compressor looks like this  when it is enabled.</p>
3	L/R Balance Control	Tap and hold to drag and control which side of the sound source is to be more emphasized.
4	PGM Level Control	Slide the volume slider to control the volume of PGM.



## Settings Panel

The Settings deck page is shown below:

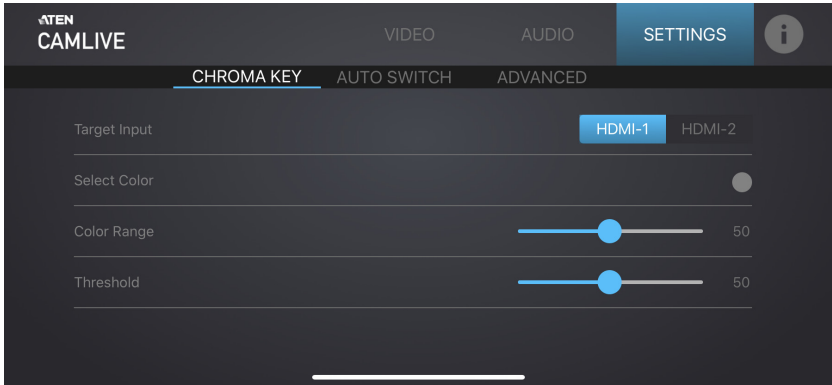

### Chroma Key

Chroma key allows user to composite two HDMI sources based on a color range, it usually goes hand-in-hand with a green screen. Our ATEN OnAir Lite App removes the color screen background and fill in the area with the HDMI sources.

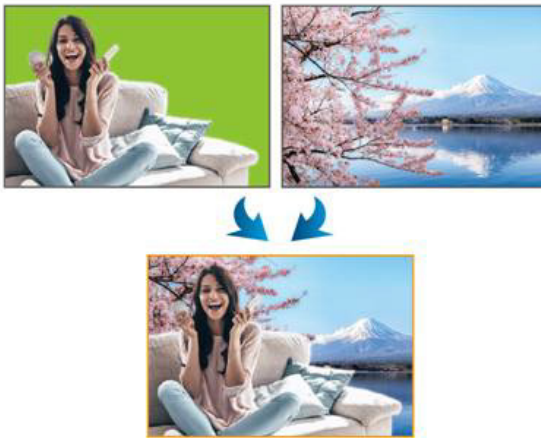

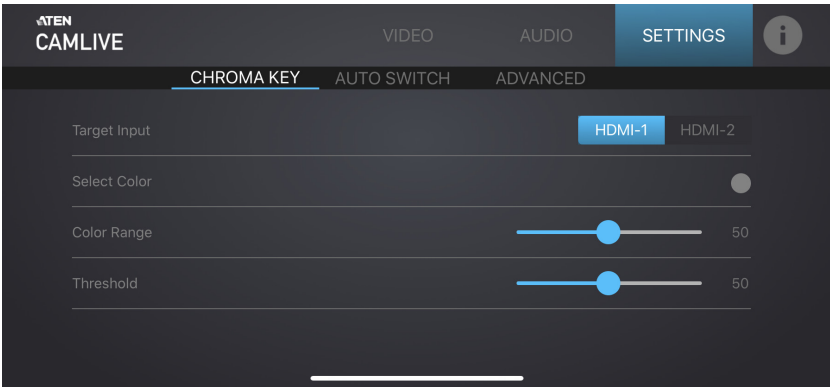

No.	Component	Description
1	Target Input	Selects a target input for the Chroma Key.
2	Select Color	Selects a color background for the HDMI input source to be fully transparent.
3	Color Range	Adjust the color range for the colored background.
4	Threshold	Adjust the threshold for the colored background.

## Selecting Color

Selects a color background for the target input by adjusting the Hue, Saturation, and Brightness. When completed, tap **Done**.

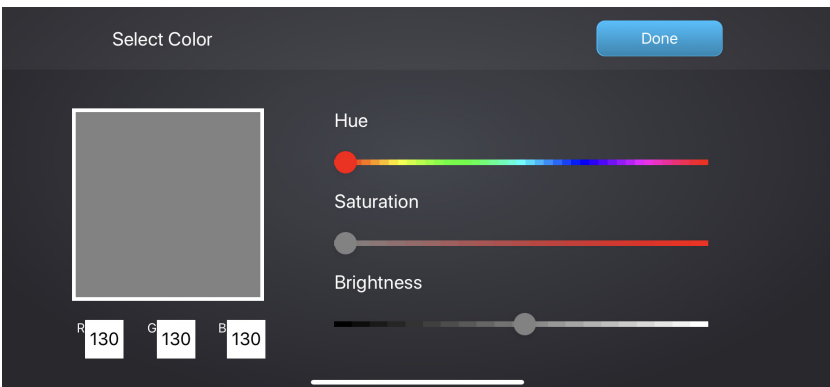

## Auto Switch

Auto switch allows user to switch the HDMI display content connected on the HDMI Program Output Port to automatically follow with the input audio source. You can select a scene for each audio input source for the auto switch.

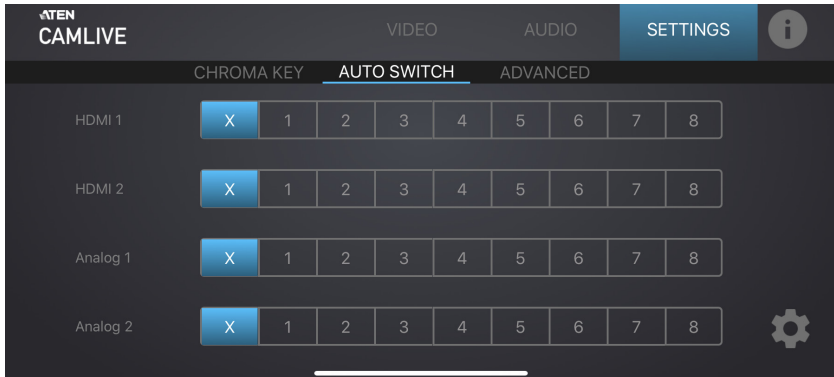
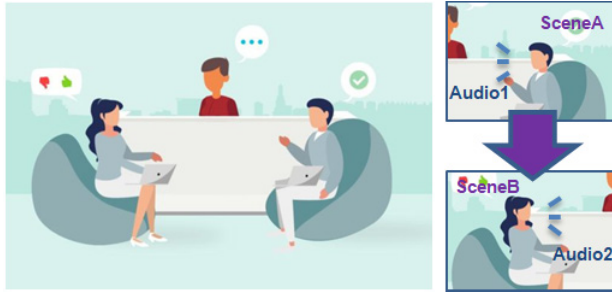

**Note:** See *Scene Selector*, page 29 for more details.

No.	Component	Description
1	HDMI 1	Selects a scene for the HDMI 1.
2	HDMI 2	Selects a scene for the HDMI 2.
3	ANALOG 1	Selects a scene for the ANALOG 1.
4	ANALOG 2	Selects a scene for the ANALOG 2.

## More Settings

Tap on the  to adjust the audio sensitivity and duration.

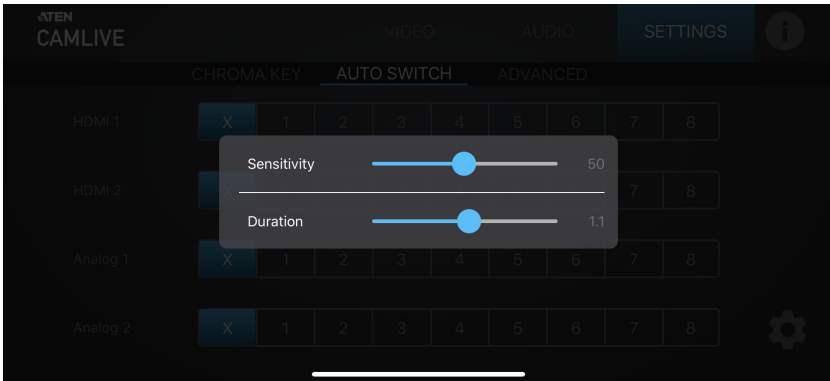

## Advanced

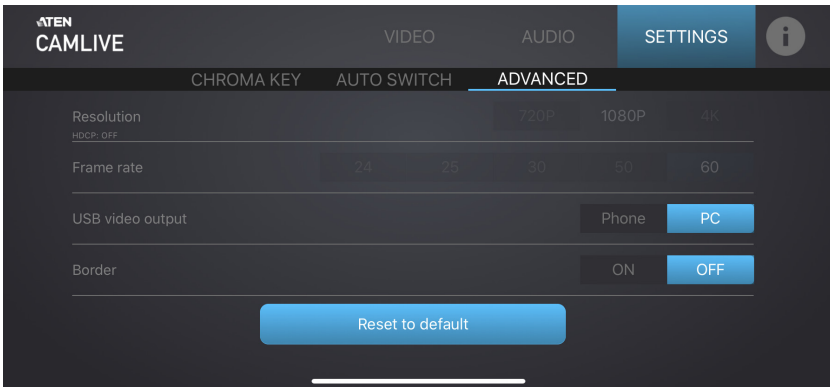

No.	Component	Description
1	Resolution	Selects a resolution for the HDMI display content when the HDCP is turned on. Note: 4K resolution is not supported when the HDCP is turned off, see <i>HDCP Switching</i> , page 23 for details.
2	Frame Rate	Selects a frame rate for the HDMI display content when the HDCP is turned on.
3	USB Video Output	Selects a USB video output between Phone and PC.
4	Border	Sets a video border for the HDMI display content.

## Resetting the CAMLIVE™ PRO

To reset the CAMLIVE™ PRO back to the factory settings, tap **Reset to default**. A warning message appears, click **OK**.

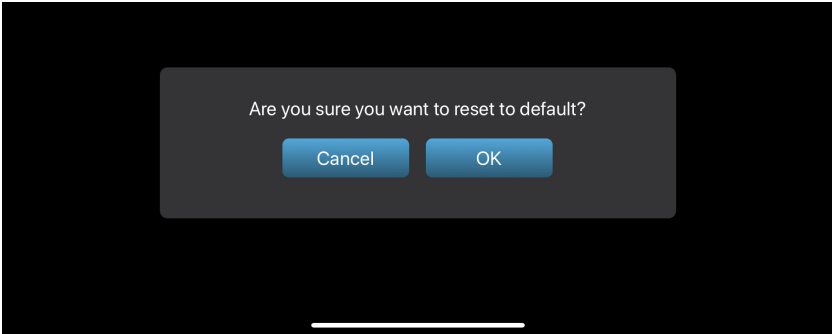

## **ATEN OnAir Lite App Factory Default Settings**

The OnAir Lite App factory default settings are as follows:

<b>Deck</b>	<b>Component</b>	<b>Setting</b>	<b>Default</b>
Video	Layout Name	1	ch1
		2	ch2
		3	PIP1
		4	PIP2
		5	PBPFH
		6	PBPFV
		7	PBP1
		8	POP
	Transition	Effect	Cut
		Duration	0.3 seconds
Audio	HDMI 1	Volume	AFV, 0dB
	HDMI 2	Volume	AFV, 0dB
	ANALOG 1 (RCA)	Volume	On, 0dB
	ANALOG 2 (XLR)	Volume	On, 0dB
		Gain	0dB
		Type	Mono
	PGM	Volume	On, 0dB
		Compressor	Off, 0dB

Settings			
Settings	CHROMA KEY	Target Input	HDMI 1
		Select Color	130 / 130 / 130
		Color Range	50
		Threshold	50
	AUTO SWITCH	HDMI 1	X
		HDMI 2	X
		Analog 1	X
		Aanalog 2	X
		Sensitivity	50
		Duration	1
	ADVANCED	Resolution	1080p (HDCP On)
		Frame Rate	60
		Border	Off
USB Video Output		PC	

This Page Intentionally Left Blank



# Chapter 5

## The Firmware Upgrade Utility

### Overview

---

The purpose of the Firmware Upgrade Utility is to provide an easy process for users to upgrade the CAMLIVE™ PRO unit to either support PC video capture, or Android smartphone video capture capability.

As new firmware versions become available, new firmware upgrade packages are posted on our website. Check the website regularly to find the latest information and packages.

### Downloading the Firmware Upgrade Package

To download the firmware upgrade package:

1. On our Website, go to *Support Center - Download* and choose the device model, or from the CAMLIVE™ PRO product page, click on the *Support and Downloads* tab, and go to *Software & Drivers*. A list of available firmware upgrade packages appears.
2. Choose the firmware upgrade package that you wish to install (usually the most recent) and download it to your computer.

---

**Note:** For Windows 7 users, please download and install the Win7\_driver from on our website after the upgrade is successful. See *Starting the Upgrade*, page 49.

---

## Preparation

---

To prepare for the firmware upgrade, do the following:

1. Press and hold the Bluetooth Link Pushbutton.



**Bluetooth Link Pushbutton**

2. Plug the power adapter cable into the power jack to power on the CAMLIVE™ PRO. The front panel LEDs blink together once every 0.5 seconds to indicate Firmware Upgrade Mode is in effect.
3. Connect the USB-B UVC Output Port to the host. If your laptop only has a USB-A interface, connect the (included) USB-B to USB-A adapter between the host and the USB-B UVC Output Port.

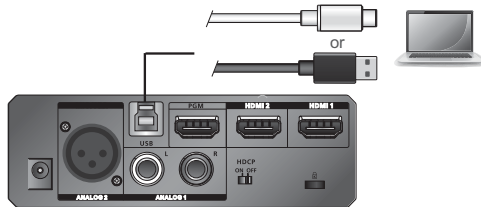

## Starting the Upgrade

To upgrade the CAMLIVE™ PRO, follow the steps below:

1. Run the downloaded Firmware Upgrade Package file – either by double clicking the file icon, or by opening a command line and entering the full path to it.

The *Firmware Upgrade Utility* Welcome screen appears:

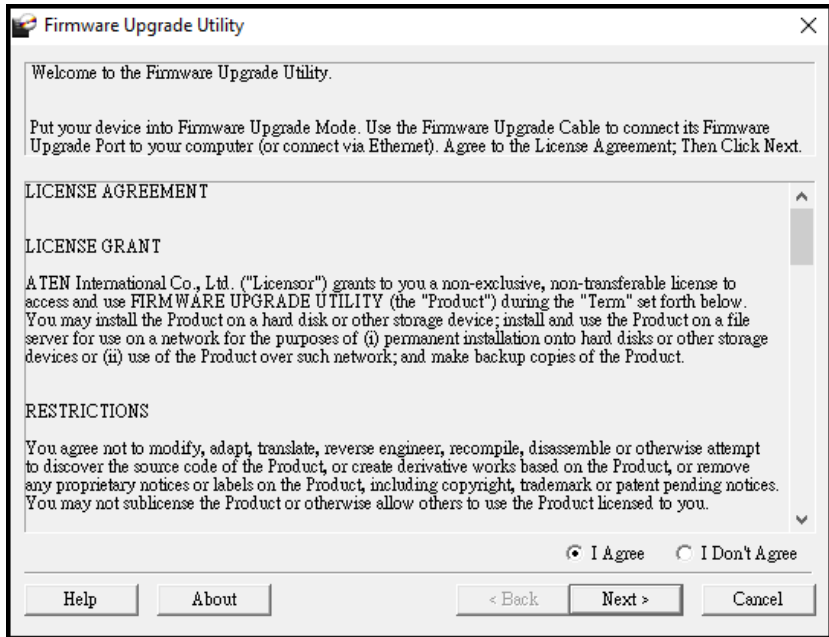

**Note:** The screens shown in this section are for reference only. The wording and layout of the actual screens put up by the Firmware Upgrade Utility may vary slightly from these examples.

2. Read the License Agreement (enable the *I Agree* radio button).

- Click **Next** to continue. The Firmware Upgrade Utility main screen appears:

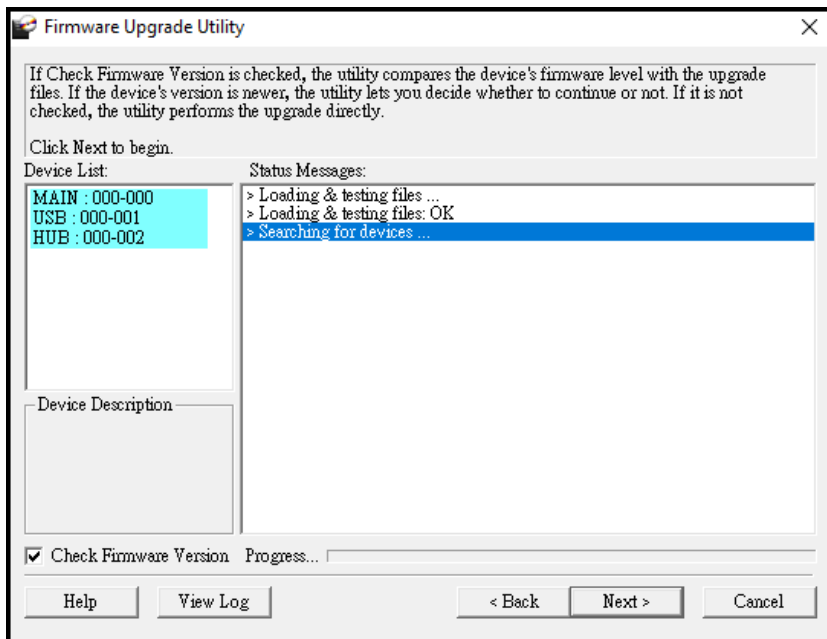

The Utility inspects your installation. All the devices capable of being upgraded by the package are listed in the *Device List* panel.

- Click **Next** to perform the upgrade.

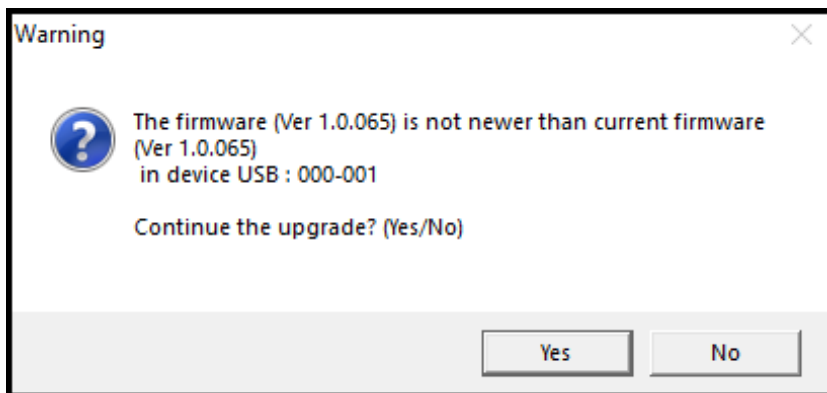

If you enabled Check Firmware Version, the Utility compares the device's firmware level with that of the upgrade files. If it finds that the device's version is higher than the upgrade version, it brings up a dialog box

informing you of the situation and gives you the option to Continue or Cancel.

If you didn't enable *Check Firmware Version*, the Utility installs the upgrade files without checking whether they are a higher level, or not.

As the Upgrade proceeds, status messages appear in the Status Messages panel, and the progress toward completion is shown on the *Progress* bar.

## Upgrade Succeeded

After the upgrade has completed, a screen appears to inform you that the procedure was successful:

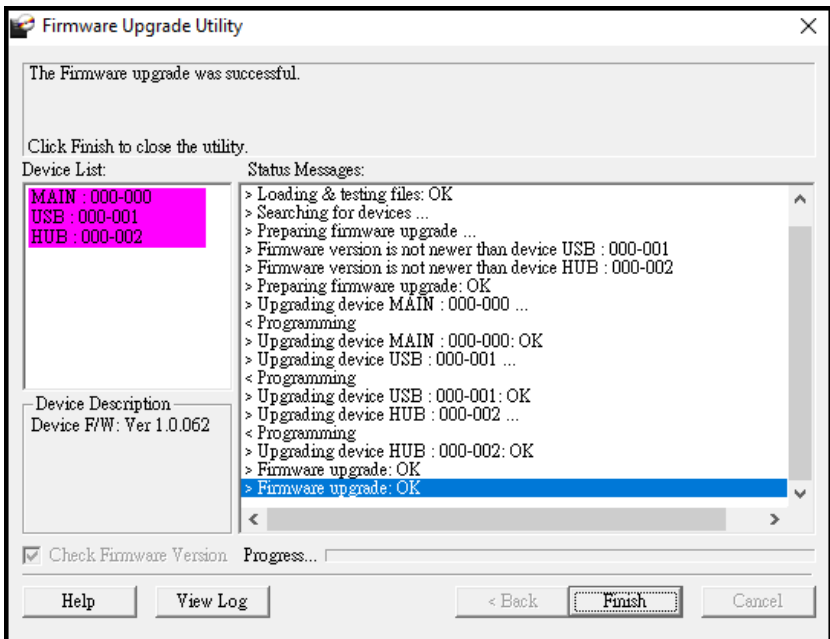

Click **Finish** to close the Firmware Upgrade Utility.

After a successful completion, the CAMLIVE™ PRO exit Firmware Upgrade Mode, and resets itself.

**Note:** For Windows 7 users, please download and install the Win7\_driver from on our website after the upgrade is successful. To download the driver, see *Downloading the Firmware Upgrade Package*, page 47.

## Upgrade Failed

---

If the *Upgrade Succeeded* screen doesn't appear, it means that the upgrade failed to complete successfully, in which case you should do the following:

1. Power off the CAMLIVE™ PRO by removing the power jack.
2. Invoke Firmware Upgrade Mode by holding down the *Bluetooth Link Pushbutton* on the front panel (see *HDMI 2 Audio Status LED*, page 4), and power on the CAMLIVE™ PRO. The front LEDs flash together.
3. Do the firmware upgrade procedure again.

## Safety Instructions

---

### General

- ◆ This product is for indoor use only.
- ◆ Read all of these instructions. Save them for future reference.
- ◆ Follow all warnings and instructions marked on the device.
- ◆ Do not place the device on any unstable surface (cart, stand, table, etc.). If the device falls, serious damage will result.
- ◆ Do not use the device near water.
- ◆ Do not place the device near, or over, radiators or heat registers.
- ◆ The device cabinet is provided with slots and openings to allow for adequate ventilation. To ensure reliable operation, and to protect against overheating, these openings must never be blocked or covered.
- ◆ The device should never be placed on a soft surface (bed, sofa, rug, etc.) as this will block its ventilation openings. Likewise, the device should not be placed in a built in enclosure unless adequate ventilation has been provided.
- ◆ Never spill liquid of any kind on the device.
- ◆ Unplug the device from the wall outlet before cleaning. Do not use liquid or aerosol cleaners. Use a damp cloth for cleaning.
- ◆ The device should be operated from the type of power source indicated on the marking label. If you are not sure of the type of power available, consult your dealer or local power company.
- ◆ The device is designed for IT power distribution systems with 230V phase-to-phase voltage.
- ◆ To prevent damage to your installation it is important that all devices are properly grounded.
- ◆ The device is equipped with a 3-wire grounding type plug. This is a safety feature. If you are unable to insert the plug into the outlet, contact your electrician to replace your obsolete outlet. Do not attempt to defeat the purpose of the grounding-type plug. Always follow your local/national wiring codes.
- ◆ Do not allow anything to rest on the power cord or cables. Route the power cord and cables so that they cannot be stepped on or tripped over.
- ◆ If an extension cord is used with this device make sure that the total of the ampere ratings of all products used on this cord does not exceed the

extension cord ampere rating. Make sure that the total of all products plugged into the wall outlet does not exceed 15 amperes.

- ◆ To help protect your system from sudden, transient increases and decreases in electrical power, use a surge suppressor, line conditioner, or uninterruptible power supply (UPS).
- ◆ Position system cables and power cables carefully; Be sure that nothing rests on any cables.
- ◆ Never push objects of any kind into or through cabinet slots. They may touch dangerous voltage points or short out parts resulting in a risk of fire or electrical shock.
- ◆ Do not attempt to service the device yourself. Refer all servicing to qualified service personnel.
- ◆ If the following conditions occur, unplug the device from the wall outlet and bring it to qualified service personnel for repair.
  - ◆ The power cord or plug has become damaged or frayed.
  - ◆ Liquid has been spilled into the device.
  - ◆ The device has been exposed to rain or water.
  - ◆ The device has been dropped, or the cabinet has been damaged.
  - ◆ The device exhibits a distinct change in performance, indicating a need for service.
  - ◆ The device does not operate normally when the operating instructions are followed.
- ◆ Only adjust those controls that are covered in the operating instructions. Improper adjustment of other controls may result in damage that will require extensive work by a qualified technician to repair.



## Technical Support

---

### International

- ◆ For online technical support – including troubleshooting, documentation, and software updates: <http://support.aten.com>
- ◆ For telephone support, see *Telephone Support*, page v:

### North America

Email Support		support@aten-usa.com
Online Technical Support	Troubleshooting Documentation Software Updates	<a href="http://www.aten-usa.com/support">http://www.aten-usa.com/support</a>
Telephone Support		1-888-999-ATEN ext 4988 1-949-428-1111

When you contact us, please have the following information ready beforehand:

- ◆ Product model number, serial number, and date of purchase
- ◆ Your computer configuration, including operating system, revision level, expansion cards, and software
- ◆ Any error messages displayed at the time the error occurred
- ◆ The sequence of operations that led up to the error
- ◆ Any other information you feel may be of help

## Specifications

Function	CAMLIVE™ PRO
<b>Connectors</b>	
Video In	2 x HDMI Type A Female (Black)
USB Port	USB 3.2 Gen1 Type-B Male (Blue) <b>Note:</b> USB-B to USB-C and USB-B to USB-A cables included in the package.
Video Output	1 x HDMI Type A Female (PGM Video, Black)
Audio Inputs	1 x Balanced Analog Audio via XLR Connectors 1 x Unbalanced Audio via RCA Connectors
<b>Video Resolution</b>	
Video Input (HDMI 1.4b support)	720p50, 720p60, 1080p24, 1080p25, 1080p30, 1080p50, 1080p60, 2160p24, 2160p25, 2160p30
PGM Video Output	UVC Capture Enabled: 720p25, 720p30, 720p50, 720p60, 1080p24, 1080p25, 1080p30, 1080p50, 1080p60 (HDCP disabled)
	UVC Capture Disabled: 720p25, 720p30, 720p50, 720p60, 1080p24, 1080p25, 1080p30, 1080p50, 1080p60, 2160p24, 2160p25, 2160p30 (HDCP enabled)
<b>Audio Sampling</b>	16-bit PCM audio, 44.1KHz and 48KHz
<b>UVC Output</b>	720P@60, 1080P@60 UVC Video Stream with UAC Audio  (Uncompressed video stream is only available on USB3.1 connection)
<b>Environmental</b>	
Operating Temperature	0 - 40 °C
Storage Temperature	-20 – 60 °C
Humidity	0 - 80% RH, Non-Condensing

Function	CAMLIVE™ PRO
<b>Minimum Hardware Requirement</b>	PC/Mac: <ul style="list-style-type: none"> <li>◆ CPU: Intel® i3 Dual Core 2.8Ghz or higher</li> <li>◆ RAM: 4GB or more</li> <li>◆ One USB-C Interface or USB-A Interface</li> </ul> Smartphone*: <ul style="list-style-type: none"> <li>◆ Android smartphone with UVC and USB-C Interface</li> </ul> <b>Note:</b> For detail UVC compatible device list, please review the following link of third part App. <a href="http://www.camerafi.com/supported-devices/">http://www.camerafi.com/supported-devices/</a>
<b>OS Support</b>	Windows 7 and later Mac OS X 10.13 and later Android 5.0.1 and later with UVC support <b>Note:</b> For Windows 7 users, please download and install the Win7_driver from on our website. To download the driver, see <i>Downloading the Firmware Upgrade Package</i> , page 47.
<b>Physical Properties</b>	
Housing	Metal
Weight	0.68 kg (1.50 lb)
Dimensions (L x W x H)	13.00 x 15.18 x 4.25 cm (5.12 x 5.98 x 1.67 in.)

## Limited Warranty

---

ATEN warrants its hardware in the country of purchase against flaws in materials and workmanship for a Warranty Period of two [2] years (warranty period may vary in certain regions/countries) commencing on the date of original purchase. This warranty period includes the LCD panel of ATEN LCD KVM switches. Select products are warranted for an additional year (see *A+ Warranty* for further details). Cables and accessories are not covered by the Standard Warranty.

### **What is covered by the Limited Hardware Warranty**

ATEN will provide a repair service, without charge, during the Warranty Period. If a product is defective, ATEN will, at its discretion, have the option to (1) repair said product with new or repaired components, or (2) replace the entire product with an identical product or with a similar product which fulfills the same function as the defective product. Replaced products assume the warranty of the original product for the remaining period or a period of 90 days, whichever is longer. When the products or components are replaced, the replacing articles shall become customer property and the replaced articles shall become the property of ATEN.

To learn more about our warranty policies, please visit our website:  
<http://www.aten.com/global/en/legal/policies/warranty-policy>