

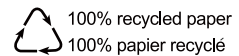

HR-32 Series

Single/Dual Channel Super Wideband True Diversity
Wireless Microphone System



Installation and Operation

Contents

01 Safety Operation and Notice	P3
02 System Performance Feature	P4
03 Front Panel Function Introduction	P6
04 Rear Panel Function Introduction	P8
05 Transmitter Function Introduction	P10
Handheld microphone (H-32/H-33)	P10
Bodypack transmitter (T-32)	P12
06 Receiver Device Installation	P14
07 Transmitter Battery Installation	P16
08 System Operation and Function	P17
Receiver display	P17
Access device main system menu or channel menu	P18
Receiver main system menu operation flowchart	P19
Receiver channel menu operation flowchart	P20
Transmitter menu operation flowchart	P21
09 User-friendly steps	P22
10 Technical Specification	P30

Thank you for choosing a RELACART professional wireless microphone system. You have joined thousands of other satisfied customers. Our years of professional experience of design and manufacturing to ensure our products' quality, performance and reliability.

01 Safety Operation and Notice

1. Please read instructions for safety operation carefully before installation and operation. Please save your safety operation guide for future reference.
2. Do not scratch, bend, twist, stretch or heat the power cord as this may cause damage to the power cord, resulting in a fire or electric shock.
3. Do not open the device shell, otherwise it may cause electric shock. If you need to repair, maintain or repair, please contact your local agent.
4. Do not touch the power plug with wet hands as this may cause a fire or electric shock.
5. Do not attempt to modify this device. Failure to do so may result in personal injury or product malfunction.
6. Do not use this equipment near water.
7. If the power cord is damaged (such as a broken wire or bare core), obtain replacement parts from your dealer. Continued use of the equipment with a damaged power cord may result in fire or electric shock.
8. To move the device he power, unplug the power cord, and unplug all connecting cables as this may damage the cable, resulting in a fire or electric shock.
9. Before cleaning the device, unplug the power cord and unplug all connecting cables. Please clean it with a dry soft cloth.
10. If the device is not in use for a long time, turn off the power, it is best to unplug the socket.
11. With the power plug and appliance coupler as the disconnecting device, it should be kept easy to operate.
12. For the safe use of the equipment and adequate ventilation, the minimum clearance around the equipment should be maintained at a distance of 5 cm or more.
13. DO NOT cover the Ventilation holes, such as: newspaper / fabric / curtains and other items.
14. Equipment should not be placed on a bare flame source, such as: lit candles.
15. Battery should not be exposed to sunshine, roasted or other high temperature overheating environment.
16. Do not throw the waste battery, please put in the designated bins.
17. Water protection rating: IPX0
18. The device can be used normally in tropical / temperate climates.
19. This product is only suitable for safe use at the altitude of 2000m and below.
20. This symbol "⚡" indicates that dangerous voltage constituting a risk of electric shock is present within this unit.
21. All Relacart products will be afforded one year free maintenance except for man-made damage, such as:
 - the device is damaged by man-made factors.
 - the device is damaged by improper operation.
 - some components are damaged or loss after the self-disassembly.

02 System Performance Feature

HR-32S/D is an ultra-wideband true diversity wireless microphone system, which perfectly combines innovative RF wireless technology and digital audio. The adaptive tracking RF filter further widens the wireless receiving bandwidth and can well avoid radio frequency interference, comprehensively improves the wireless RF performance to ensure the stability of the entire system, and the DSP audio digital processing technology is specially tailored for performances that pursue sound quality effects. The built-in radio frequency visualization module can display the on-site radio frequency environment in front of your eyes, and can provide a basis for judgment in frequency setting and planning. True diversity reception and support for automatic frequency Scan function, supporting PC control software, can manage up to 64 devices at the same time. Support for extended Dante audio protocol output.

03 Front Panel Function Introduction

Key Features:

- Adopt high-speed DSP chip, 24-bit high-performance ADC/DAC, and self-developed digital audio extension algorithm to reduce the noise caused by wireless transmission.
- Built-in 9 kinds of digital audio simulators and 1 kind of custom-made simulator [Magic EQ], users can directly call out the sound quality they like. You can also adjust the parameters to get your favorite tone.
- Automatic frequency selection [AFS] can automatically search for clean and interference-free frequencies in the actual environment. The on-site radio frequency environment is visualized in front of the eyes. Users can choose to automatically set the frequency or set it manually.
- Infrared automatic frequency pairing [IR] function, which can be conveniently and quickly set up synchronously with the transmitter.
- Ultra-wide frequency band, the receiving and transmitter working frequency band can reach up to 134MHz, and can support up to 48 channels working at the same time.
- True diversity reception, each channel has a built-in adaptive tracking RF filter to ensure the stability of wireless transmission.
- Sophisticated low-power circuit design, the transmitter uses 2 AA alkaline batteries, and can work continuously for up to 9 hours.
- The matching PC control software [RWW] can manage up to 64 devices at the same time.
- Antenna input supports external antenna power supply, providing DC 12V 150mA power supply for external antenna extensions.
- Optional Dante digital audio output, which has been certified by Audinate, can be connected to any Dante certified audio equipment.

(HR-32S Single channel)

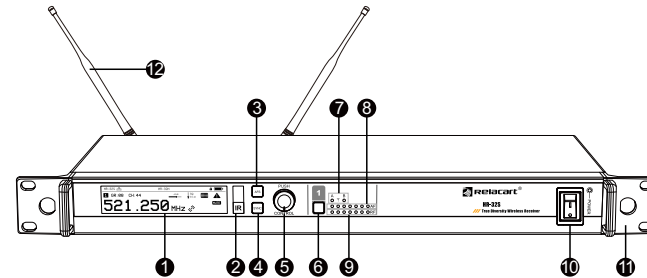

(HR-32D Dual channel)

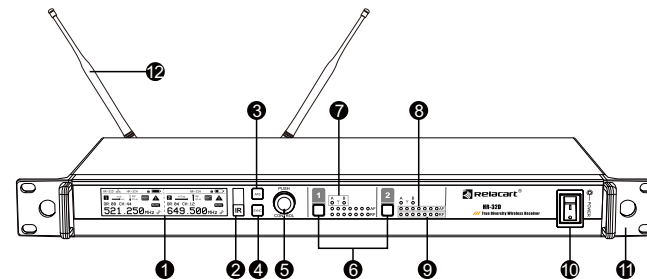

04 Rear Panel Function Introduction

- 1 TFT high-brightness screen: Displays setting values and parameters as well as operating menus.
- 2 Infrared data transmission window (iR): It is used to transmit the channel data of the receiver to the transmitter, so that the frequency of the transmitter and the receiver are consistent to achieve synchronization.
- 3 "AFS" frequency selection button: After using it with the "1/2" channel button, press this button again, and the receiver will automatically search and lock on the interference-free channel in the actual working environment.
- 4 "SYNC" button: When the infrared frequency window of the receiver and transmitter is aligned, after using it with the "1/2" channel button, press this button again, synchronization of transmitters via IR interface from receiver.
- 5 "CONTROL" Button: Long press it for 3 seconds to enter the menu settings, short press to select a channel or menu item, turn clockwise/counterclockwise to scroll between menu items or edit parameter values.
- 6 Channel selection button: Press the corresponding channel selection button to enter the independent channel setting parameters or exit the channel menu.
- 7 Antenna status indicator: Indicates the receiving channel, it will switch between A and B, and the system will automatically switch to the channel with the best work.
Note: At least one green LED must be on for the receiver to output audio signals.
- 8 AF audio indicator: Indicates the output audio level, and the red indicator long light indicates that the signal is overloaded and distorted.
- 9 RF signal strength indicator light: used to indicate the strength of the RF signal from the transmitter.
- 10 Power switch POWER (with indicator light).
- 11 Rack mount fixture: Fixed installation.
- 12 Channel 1/2 wavelength BNC antenna: used to receive radio waves transmitted by the transmitter.

(HR-32S Single channel)

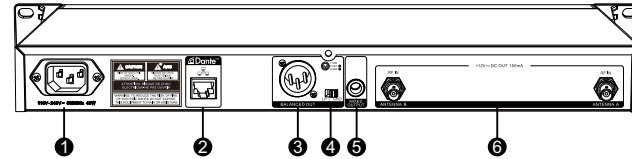

(HR-32D Dual channel)

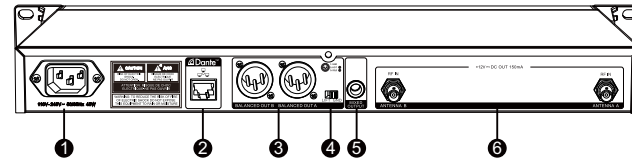

05 Transmitter Function Introduction

- 1 Power input socket: standard IEC socket, which can adapt to work in 100-240V 50/60Hz AC power supply.
- 2 Ethernet/Dante network port: connect to LAN to transmit Dante digital audio signal and control signal, realize audio distribution, monitoring and recording – Refer to "Dante Network" topic. (Dante network function optional)
- 3 Balanced audio output port: microphone analog audio output, XLR balanced output interface, independent output for each channel.
- 4 LIFT/GND switch: XLR output ground switch, can make the XLR ground pin empty or grounded.
- 5 Unbalanced audio output port (mixed): microphone analog audio output, mixed mode output, $\Phi 6.3\text{mm}$ port.
- 6 RF antenna input connector: suitable for connecting antenna A and antenna B, BNC interface, and supports DC 12V/150mA power output.

Handheld microphone (H-32)

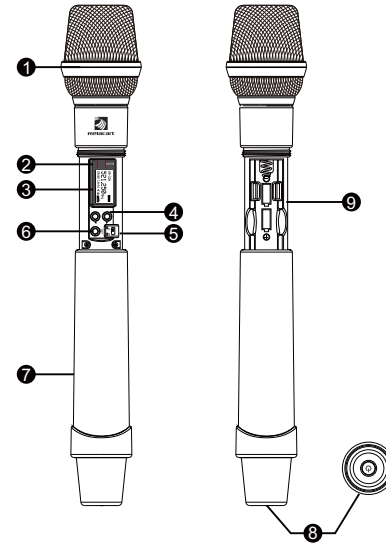

Handheld microphone (H-33)

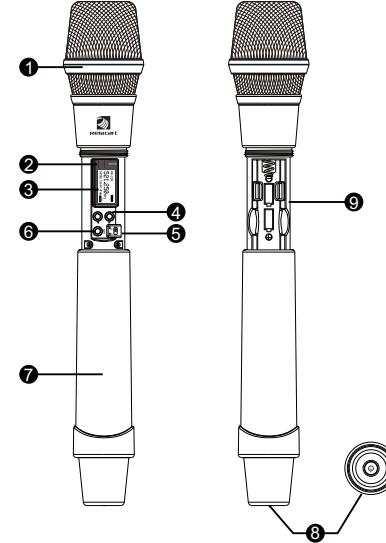

- ❶ Microphone pickup module (optional): The main component that converts sound into audio signals. This module has different specifications for users to choose from.
- ❷ Infrared data transmission window (iR): During the infrared synchronization process, aiming at the infrared port of the receiver allows the transmitter to synchronize with the receiver.
* During infrared pairing, the tail cover must be unscrewed; otherwise, the pairing function may be affected.
- ❸ OLED display: display operating frequency, channel, MUTE and battery power, etc. Battery power indicator, fully charged is 4 bars, when there is only 1 bar left, please replace the new battery as soon as possible.
- ❹ "▲ / ▼" button: Used to scroll between menus or edit parameter values.
- ❺ "SET" button: Long press to enter the menu setting, short press to confirm the menu and confirm the parameter change and display it on the screen.
- ❻ Lock switch: Toggle the switch according to the icon to lock or unlock the transmitter controls.
- ❼ Handle: unscrew to reveal the battery compartment; when installing or replacing batteries or setting infrared frequency binding, the handle must be opened.
- ❽ Power button:
 - A. Power supply: Touch to turn on the power supply of the transmitter. At this time, the backlight of the button is green. Press and hold for 3 seconds to turn off the transmitter.
 - B. MUTE: When the handheld microphone is powered on, press it lightly to enable or cancel the mute state.
- ❾ Battery compartment: 2 AA batteries can be loaded. (It is best to use alkaline 1.5V AA batteries, please replace two batteries at the same time when replacing new batteries.)
Warning: Do not install the battery with the wrong polarity, it may damage the internal electronic parts.

Bodypack transmitter (T-32)

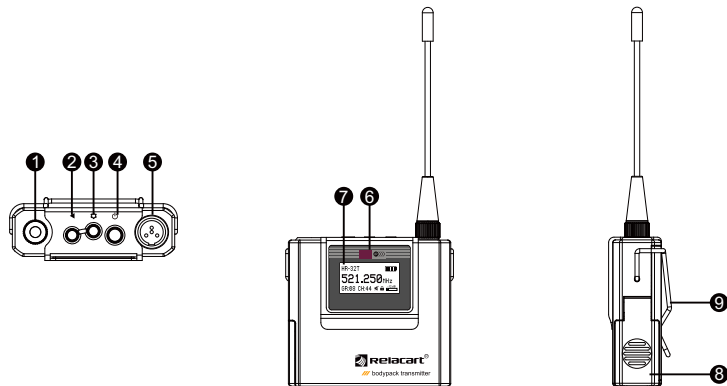

- ❶ Antenna interface, a standard SMA RF connector, used to connect the transmitting antenna.
Note: The transmitter antenna must be connected when using and make sure the antenna frequency is matching the microphone.
- ❷ "▶" button: Used to scroll between menus or edit parameter values.
- ❸ "⚙️" button: Long press to enter the menu setting, short press to confirm the menu and parameter changes and display on the screen.

06 Receiver Device Installation

- ④ “” power button:
 - A. Power supply: Touch to turn on the power supply of the transmitter, press and hold for 3 seconds to turn off the transmitter.
 - B. Mute: When the handheld microphone is powered on, press it lightly to enable or cancel the mute state.
- ⑤ Mini 4-type XLR port: Accepts a 4-pin lavalier microphone or instrument cable.
Mini XLR pin protocol: 1 (ground), 2 (power), 3 (audio), 4 (empty pin)
- ⑥ Infrared data transmission window (iR): During the infrared synchronization process, aiming at the infrared port of the receiver allows the transmitter to synchronize with the receiver.
- ⑦ OLED display: Display operating frequency, channel, mute and battery power, etc. Battery power indicator, fully charged is 4 bars, when there is only 1 bar left, please replace the new battery as soon as possible.
- ⑧ Battery cover: Pull to open the valve of the battery compartment, and one AA battery can be loaded. (Alkaline 1.5V AA batteries are recommended.)
Warning: Do not install the battery with the wrong polarity, it may damage the internal electronic parts.
- ⑨ Fixing clip: Used to fix the waist pack around the user's waist.

(HR-32S Single channel)

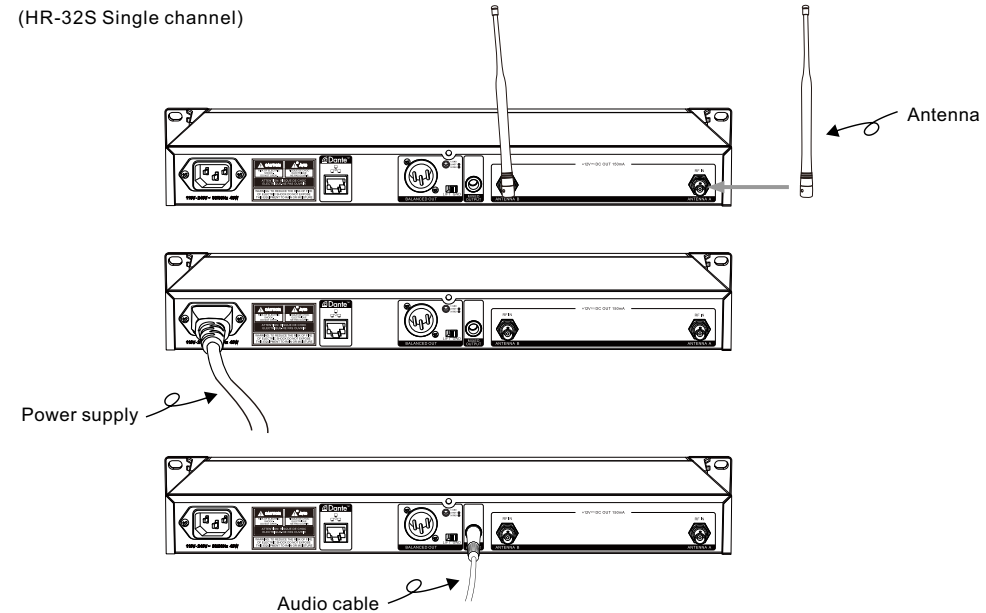

07 Transmitter Battery Installation

(HR-32D Dual channel)

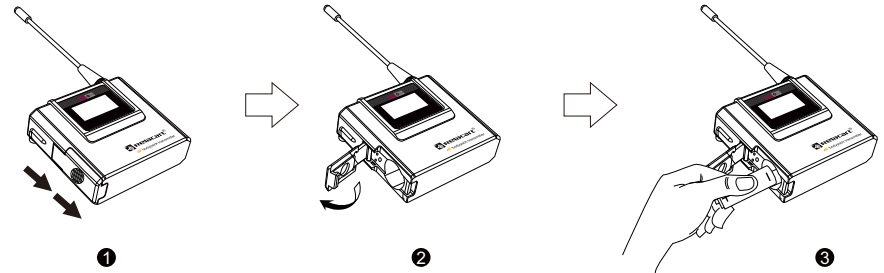
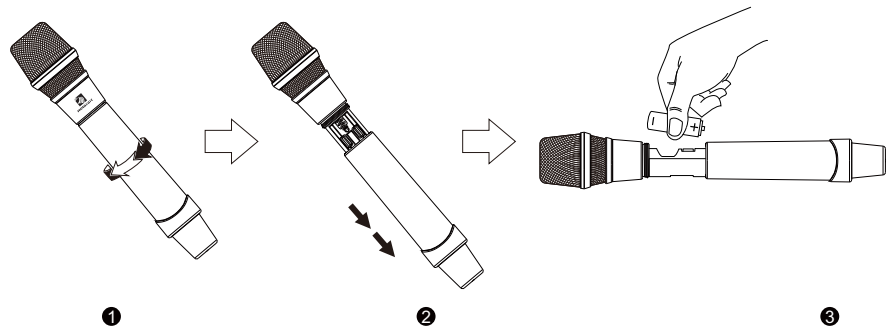
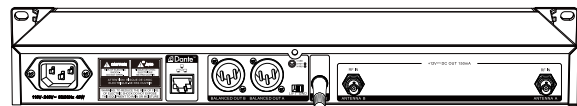
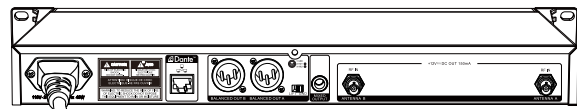
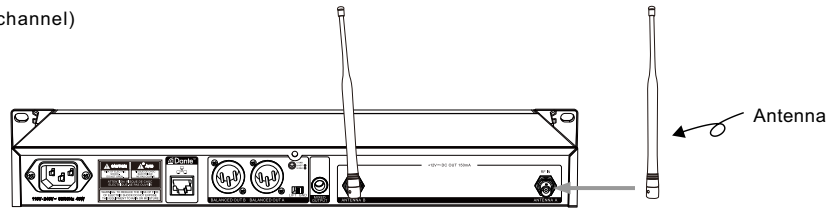

08 System Operation and Function

Receiver display

(HR-32S Single channel display)

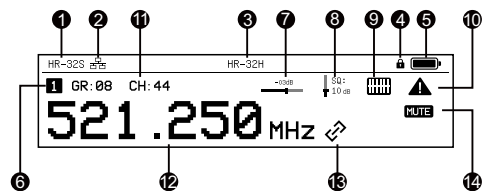

(HR-32D Dual channel display)

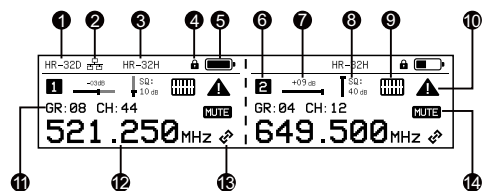

- 1 The receiver customizes the device name.
- 2 Other Relacart device or RWW network connection.
- 3 The device name of the connected transmitter.
- 4 Indicates that the controls for a connected transmitter are locked.
- 5 Indicates the battery charge status of the connected transmitter.
- 6 Channel number: Display the currently connected channel interface.
 1: Indicates that the transmitter is not paired.
 1: Indicates that the transmitter has been paired successfully.
- 7 Display the currently set input volume output value.
- 8 Display the currently set SQ squelch threshold parameter.
- 9 Displays the status icon of the currently set EQ.
- 10 Indicates an alert or warning.
- 11 Display the current working frequency group and channel.
- 12 Displays the current operating frequency.
- 13 Indicates that the transmitter is paired with the receiver channel.
- 14 Indicates that the transmitter is in mute mode.

Access device main system menu or channel menu

From the main interface, use the following methods to access the main system menu or enter one of the channel menus.

- To enter the main menu of the device system, long press the “CONTROL” wheel.

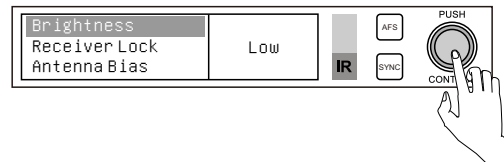

- To enter the channel menu, select the corresponding channel number key and press and hold the “CONTROL” wheel to access the channel menu

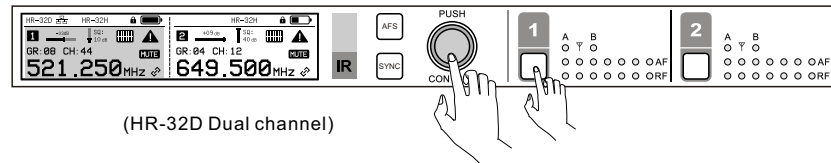

(HR-32D Dual channel)

Receiver main system menu operation flowchart:

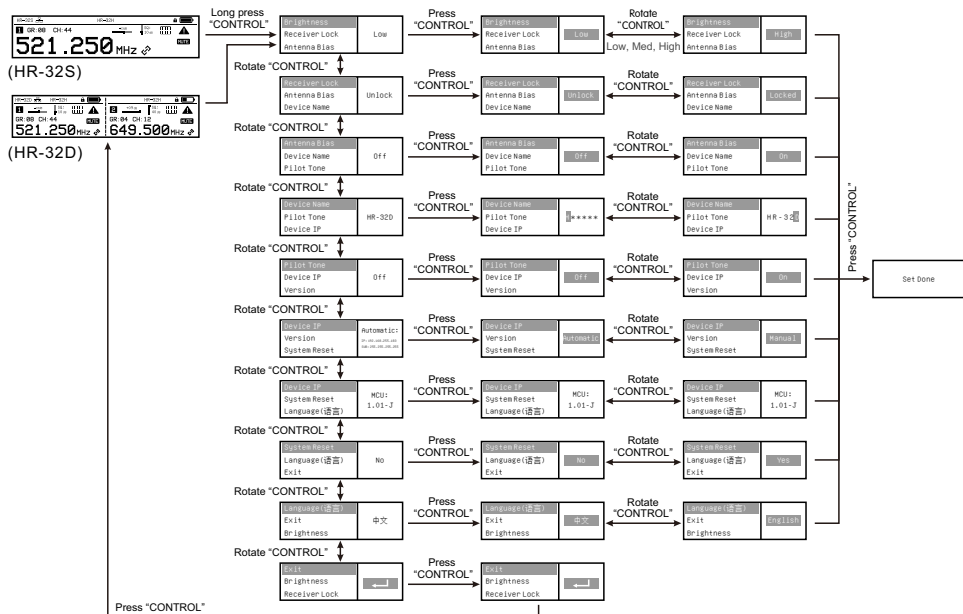

Receiver channel menu operation flow chart:

* According to the corresponding channel number button, the **1** or **2** display area of the display will light up, and then long press the "CONTROL" wheel to enter the channel menu setting selection.

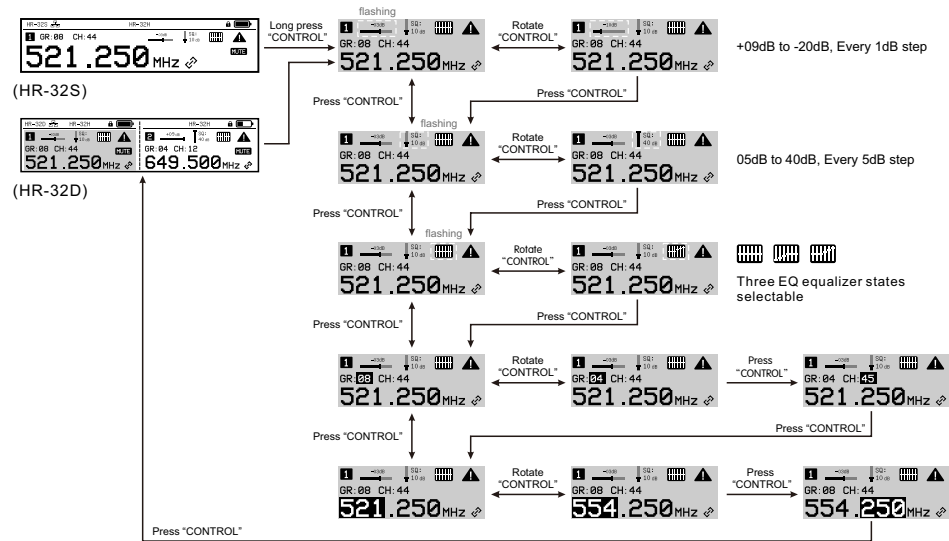

09 User-friendly steps

Transmitter menu operation flowchart:

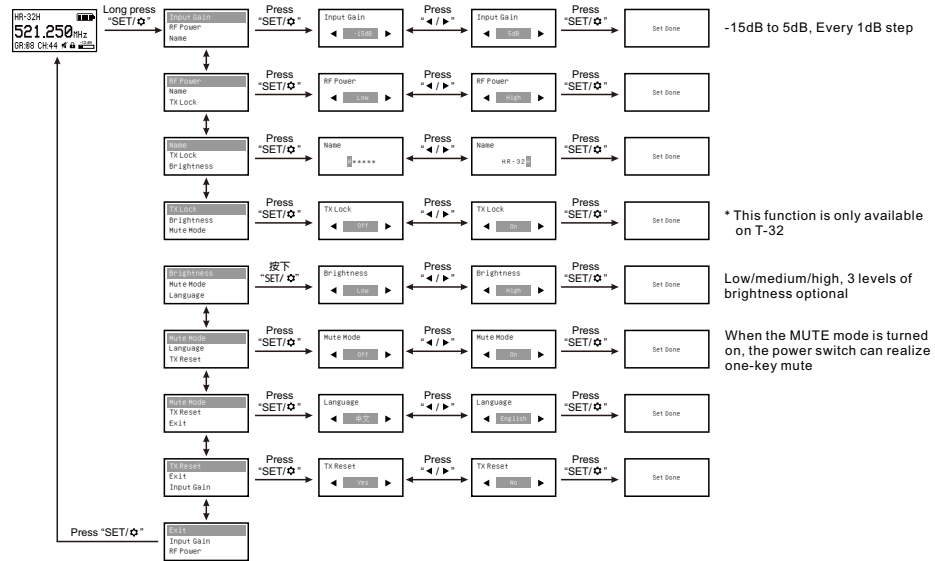

1. After connecting the antenna and the power adapter, turn on the receiver by pressing the power button ("I" symbol), the display and power indicator are all on. (As shown below)

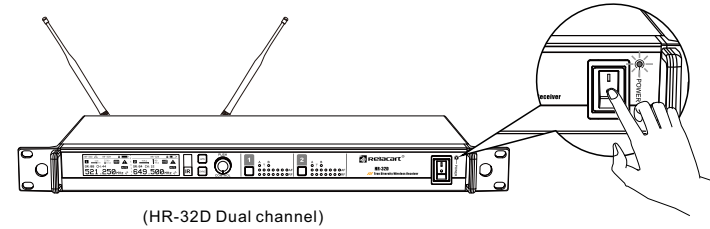

2. Long press the "CONTROL" wheel of the receiver to enter the system main menu setting.

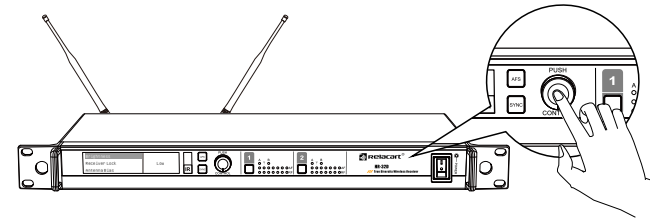

Turn the "CONTROL" control wheel clockwise or counterclockwise to browse menu items or select parameters, short press the "CONTROL" wheel to enter the setting or confirmation menu

NOTE: Any changed settings will be immediately accepted by the unit and transferred from the primary unit to the secondary unit. Select "Exit" to exit the setting mode and return to the main interface; if the "CONTROL" wheel is not pressed within a few seconds, it will automatically exit the setting mode.

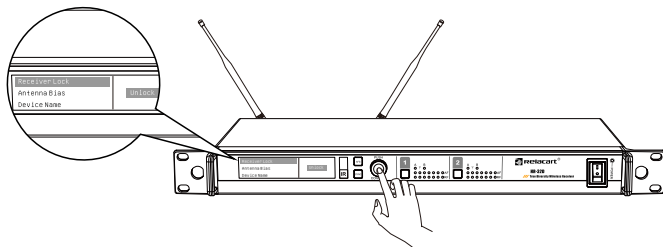
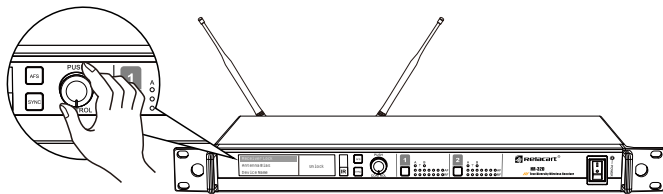

3. Press the corresponding channel number button, when the **1** or **2** area of the display is on, press and hold the "CONTROL" wheel to enter the single channel menu setting.

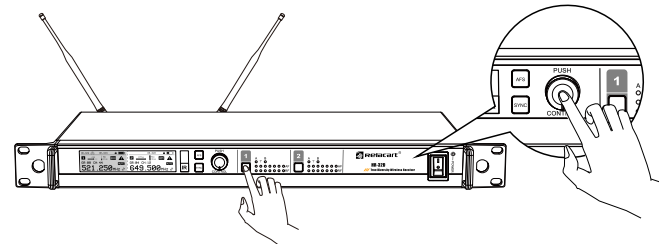

When setting a single-channel menu, short press the "CONTROL" wheel to gradually select the setting or confirmation of the next menu item; turn the "CONTROL" wheel clockwise or counterclockwise to edit the parameters of the currently selected menu item, and then press the "CONTROL" wheel, and automatically enter the next level of selection after confirming the setting.

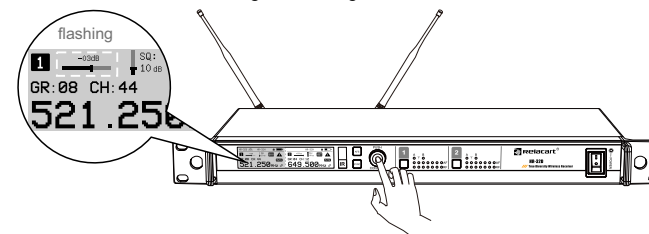

a. Manually set frequency groups and channels

If you need to select a specific channel, you can manually set the frequency group and channel, use the control wheel to select the number of GR, CH channels. Press the "CONTROL" wheel to enable editing, turn it to change the value, press the "CONTROL" wheel again to save the changes.



b. Manually set the frequency

If you need to choose a specific value, you can set the frequency manually, using the control wheel to select the FREQ (MHz) parameter. Press the "CONTROL" wheel to enable editing, turn it to change the value, press the "CONTROL" wheel again to save the changes.



4. Press the corresponding channel number button, and then press the "AFS" button to enter the scanning interface.

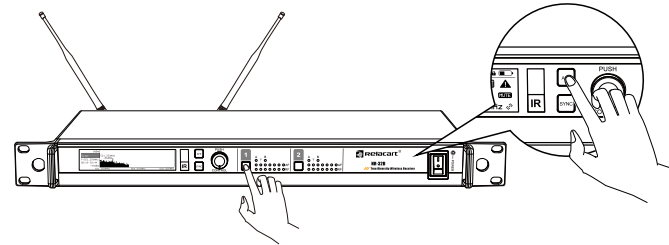

- a. If you find that there is interference in the channel, turn the "CONTROL" wheel clockwise or counterclockwise to select "AUTO" or "MANUAL". (If there is no interference, skip the "AFS" operation and return to the main interface)

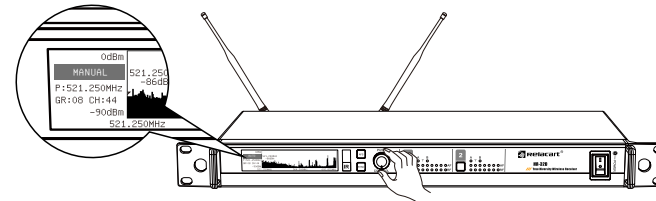

When "MANUAL" is selected, press the "CONTROL" wheel, and after a bar is displayed on the interface, turn the "CONTROL" wheel to freely select the frequency.

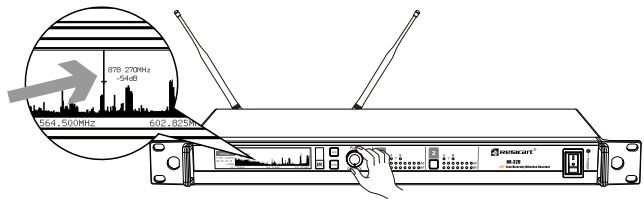

b. The scanned channel automatically calculates a clean and interference-free frequency, and the "RF" radio frequency indicator on the receiver panel is off. If it lights up in red, it indicates that the scanned channel is interfered, and this action can be repeated, until a clean frequency is found.

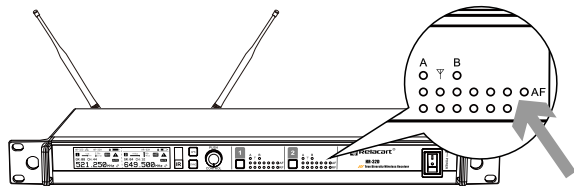

5. Press the corresponding channel number button, align the infrared frequency window of the transmitter with the iR infrared frequency window of the receiver, and then press the "SYNC" button to enter the infrared frequency binding interface. (Note: Pressing "SYNC" directly cannot achieve synchronous pairing. If the synchronization fails, please try this operation again and ensure that the infrared window of the transmitter is exposed.)

(HR-32S)

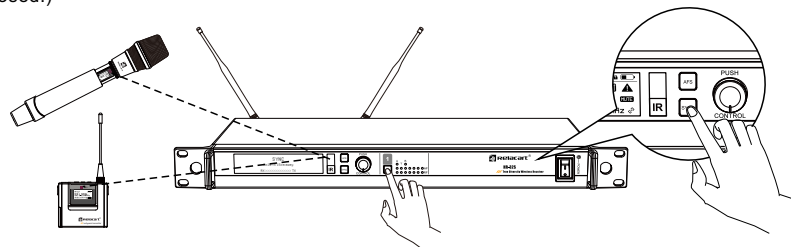

(HR-32D)

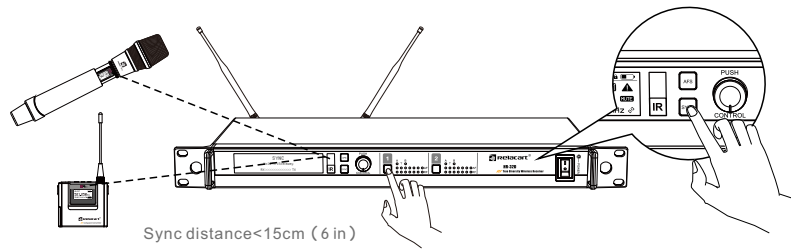

10 Technical Specification

The frequency of the transmitter and the receiver are synchronized. When the microphone speaks, the "AF" audio indicator on the receiver panel will flash to indicate that there is audio output.

(HR-32S)

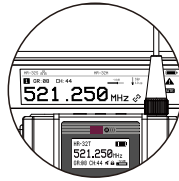
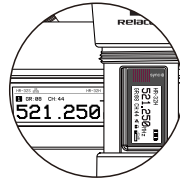
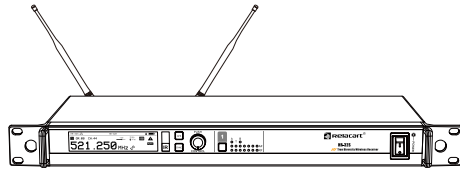

(HR-32D)

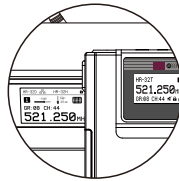
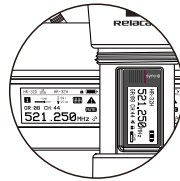
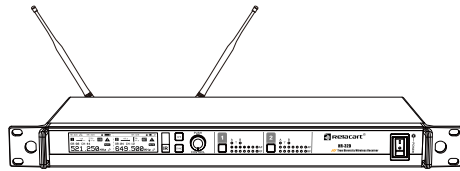

Channel display (the frequency of the receiver and the transmitter are the same)

HR-32S Single channel receiver

Main Frame Size:	EIA Standard Rack 1U
Receiving Channel:	Single Channel
Frequency Reliability:	$\pm 0.005\%$ (-10° C ~ 50° C)
Oscillation Mode:	PLL frequency synthesis technology
Receiving Sensitivity:	When the offset is equal to 25KHz and 5dBu is input, S/N>60dB
Bandwidth:	130MHz (depending on the region)
Max. Deviation:	$\pm 45\text{KHz}$
Audio Sampling Rate:	96KHz 24-bit
Audio Extension:	Relacart DSP digital audio extension algorithm
Comprehensive S/N:	>105dB
Comprehensive T.H.D:	<0.7%@1KHz
Frequency Response:	60Hz~18KHz $\pm 3\text{dB}$
Working Range:	100M Typical (in open space)
Antenna Interface:	BNC, DC +12V/150mA output
Audio Interface:	6.3mm unbalanced audio output, XLR balanced audio output
Ethernet Port:	Support Dante audio protocol
Power Supply:	AC 100~240V, 50/60Hz
Dimension (mm):	480 (W) x 350 (D) x 43 (H)
Weight:	Approximately 1Kg

HR-32D Dual channel receiver

Main Frame Size:	EIA Standard Rack 1U
Receiving Channel:	Dual Channel
Frequency Reliability:	±0.005% (-10° C ~ 50° C)
Oscillation Mode:	PLL frequency synthesis technology
Receiving Sensitivity:	When the offset is equal to 25KHz and 5dBu is input, S/N>60dB
Bandwidth:	130MHz (depending on the region)
Max. Deviation:	±45KHz
Audio Sampling Rate:	96KHz 24-bit
Audio Extension:	Relacart DSP digital audio extension algorithm
Comprehensive S/N:	>105dB
Comprehensive T.H.D:	<0.7%@1KHz
Frequency Response:	60Hz~18KHz ±3dB
Working Range:	100M Typical (in open space)
Antenna Interface:	BNC, DC +12V/150mA output
Audio Interface:	6.3mm unbalanced audio output, XLR balanced audio output
Ethernet Port:	Support Dante audio protocol
Power Supply:	AC 100~240V, 50/60Hz
Dimension (mm):	480 (W) x 350 (D) x 43 (H)
Weight:	Approximately 1.8Kg

H-32 Handheld microphone

Harmonic Radiation:	<45dBm
Bandwidth:	Single channel 134MHz (Depending on the region)
Modulation:	FM
Audio Compression:	Relacart classic audio compression circuit
Microphone Element:	Dynamic/Condenser(removable)
RF Output Power:	50mW/100mW
Battery:	AA x2
Current Consumption:	175mA (Typical)
Battery Current/Life:	Approximately 9 hours (alkaline)
Dimension (mm):	53 (Φ) x 275 (L)
Weight:	Approximately 349g (w/o battery)

H-33 Handheld microphone

Harmonic Radiation:	<45dBm
Bandwidth:	Single channel 134MHz (Depending on the region)
Modulation:	FM
Audio Compression:	Relacart classic audio compression circuit
Microphone Element:	Dynamic/Condenser (removable)
RF Output Power:	50mW/100mW
Battery:	AA x2
Current Consumption:	175mA (Typical)
Battery Current/Life:	Approximately 9 hours (alkaline)
Dimension (mm):	53 (Φ) x 275 (L)
Weight:	Approximately 354g (w/o battery)

T-32 Bodypack transmitter

Oscillation:	PLL synthesized
Harmonic Radiation:	<45dBm
Max. Deviation:	±45KHz
Input Connector:	4-pin miniXLR connector
RF Output Power:	10mW/50mW
Battery:	AA x 1
Current Consumption:	205mA (Typical)
Battery Current/Life:	Approximately 5 hours (alkaline)
Dimension (mm):	66 (H) x 63 (W) x 20 (D)
Weight:	Approximately 85g (w/o battery)